



05362000 - LT-T D60 ER11F H47-105

Tipo	LT-T Portautensili tiltabile
Attacco	GAMBO CILINDRICO 60
Uscita utensile	Portapinza ER 11 F
Raffreddamento	Refrigerazione esterna
Senso di rotazione	r1  r2 
Velocità max [1/min]	6000
Coppia max [Nm]	5
Rapporto	1:1
H [mm]	47-105
Accessori	N.D.
Note	N.D.
Note per il montaggio	Può avere delle limitazioni per alcune installazioni



Verificare sempre gli ingombri del portautensile in torretta

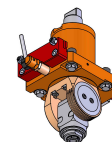
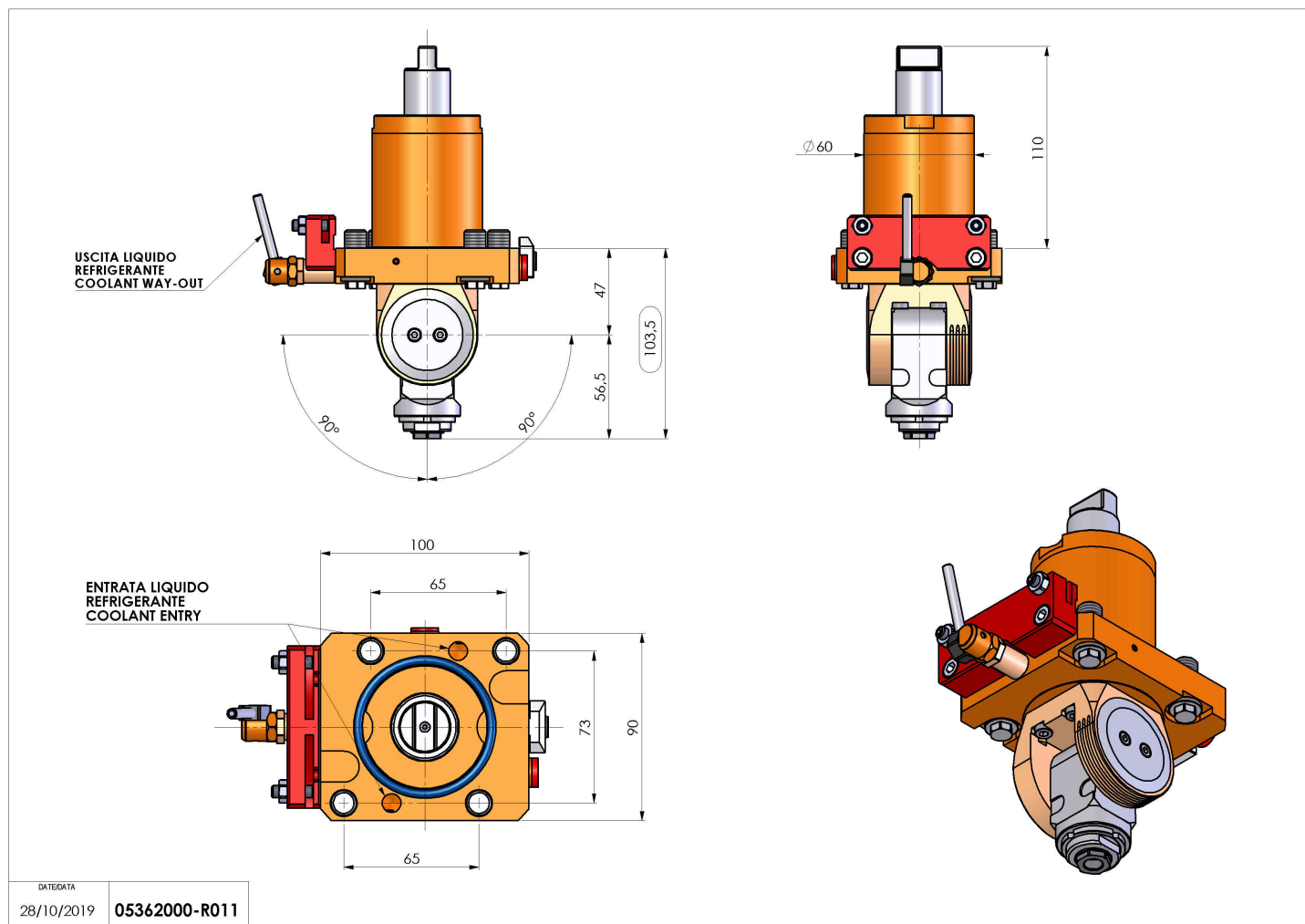

Salvo modifiche tecniche

DATE/DATE
28/10/2019 05362000-R011