



05334300 - LT-A BMT55 ER32 LR 2:1 H85

Tipo	LT-A Portautensili angolare a 90°
Attacco	BMT 55
Uscita utensile	Portapinza ER 32
Raffreddamento	Refrigerazione esterna
Senso di rotazione	r1  r2 
Velocità max [1/min]	in 6000 / out 3000
Coppia max [Nm]	in 70 / out 140
Rapporto	2:1
H [mm]	85
H1 [mm]	38
Accessori	N.D.
Note	N.D.
Note per il montaggio	Può avere delle limitazioni per alcune installazioni



Verificare sempre gli ingombri del portautensile in torretta

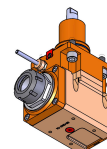
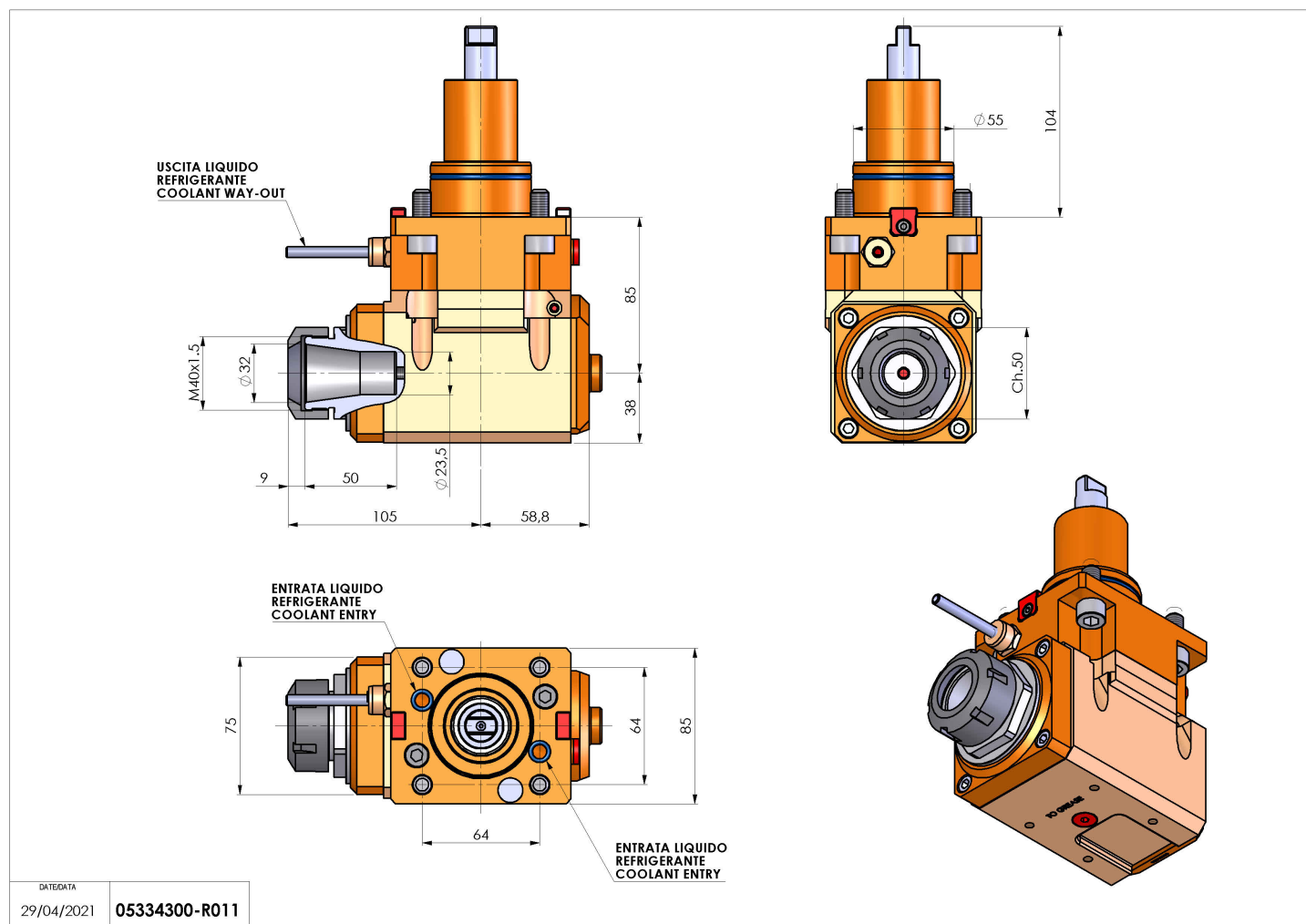

Salvo modifiche tecniche