



05238900 - LT-S BMT55EM4 ER32F H60

Tipo	LT-S Portautensili dritto
Attacco	BMT 55 EM
Uscita utensile	Portapinza ER 32 F - ghiera interna
Raffreddamento	Refrigerazione esterna
Senso di rotazione	r1  r2 
Velocità max [1/min]	6000
Coppia max [Nm]	60
Rapporto	1:1
H [mm]	60
Accessori	N.D.
Note	N.D.
Note per il montaggio	Può avere delle limitazioni per alcune installazioni



Verificare sempre gli ingombri del portautensile in torretta

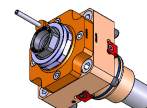
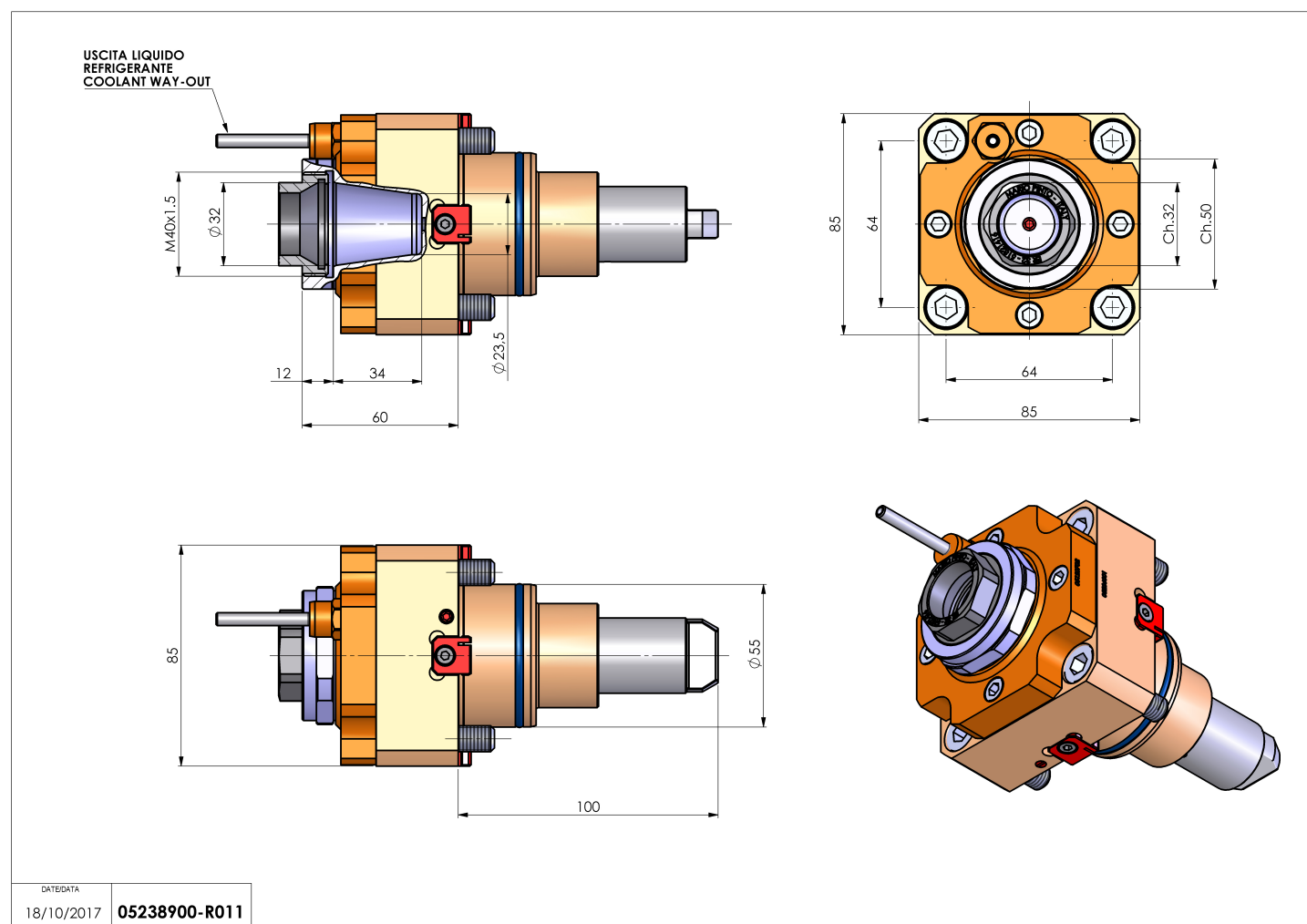

Salvo modifiche tecniche

DATE/DATE	05238900-R011
18/10/2017	