



05311900 - LT-S BMT55 BD ER25 H80

Tipo	LT-S Portautensili dritto
Attacco	BMT 55 BIG DRIVE
Uscita utensile	Portapinza ER 25
Raffreddamento	Refrigerazione esterna
Senso di rotazione	r1  r2 
Velocità max [1/min]	6000
Coppia max [Nm]	60
Rapporto	1:1
H [mm]	80
Accessori	N.D.
Note	N.D.
Note per il montaggio	Può avere delle limitazioni per alcune installazioni



Verificare sempre gli ingombri del portautensile in torretta

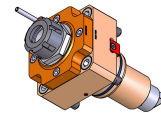
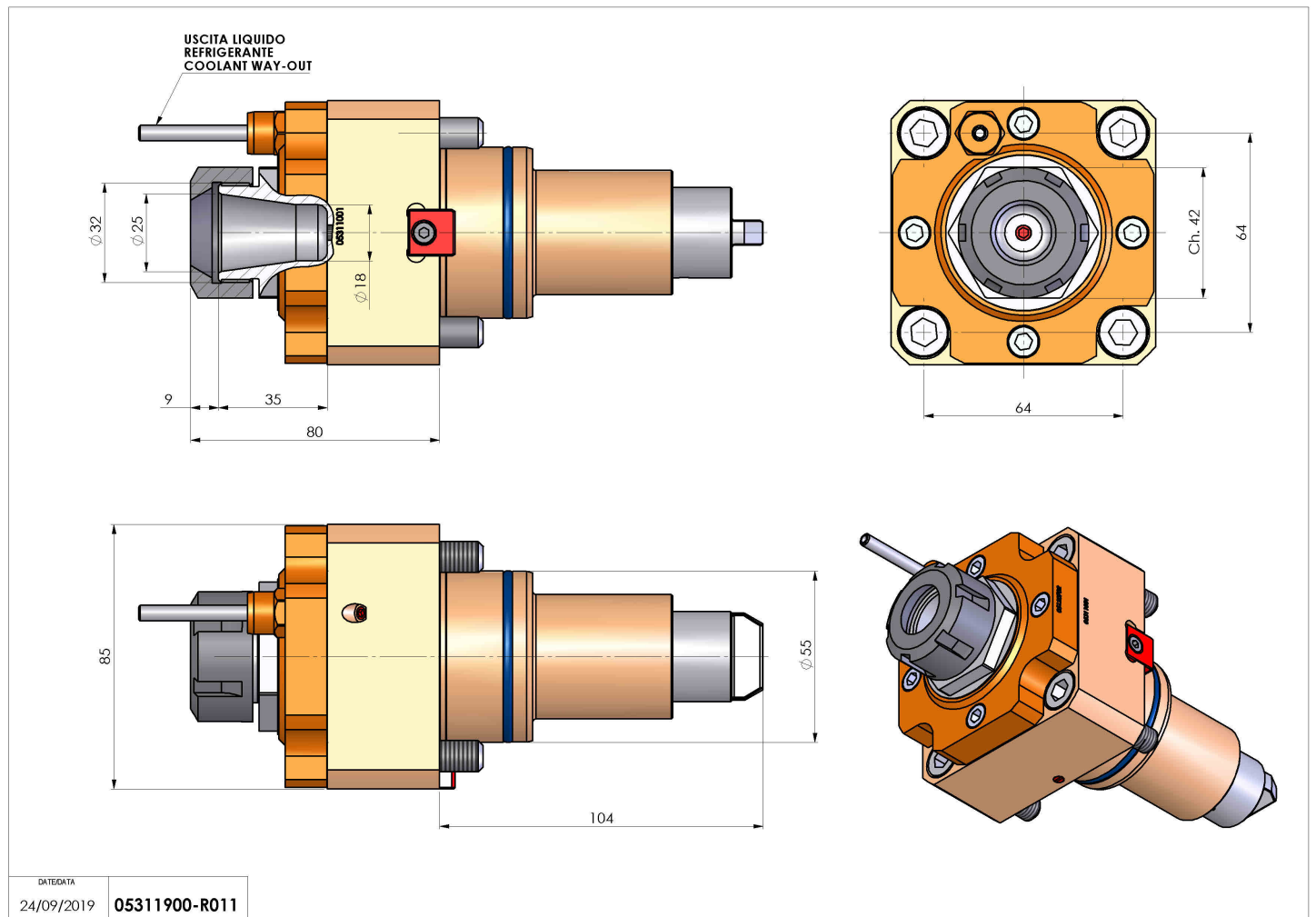

DATE/DATE
24/09/2019 05311900-R011

Salvo modifiche tecniche