

06305700 - TH-RAD BMT65 1"X1" L-R H75

Type	TH-RAD Radial Tool holder
Mounting	BMT 65
Tool output	Radial Square Tool Holder 1"x1"
Coolant	External coolant
H [mm]	75

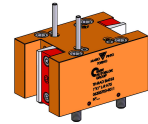

Accessories	N.A.
Notes	N.A.
Mounting tips	Not suitable for every application, please check

Always check live tool dimensions on the turret

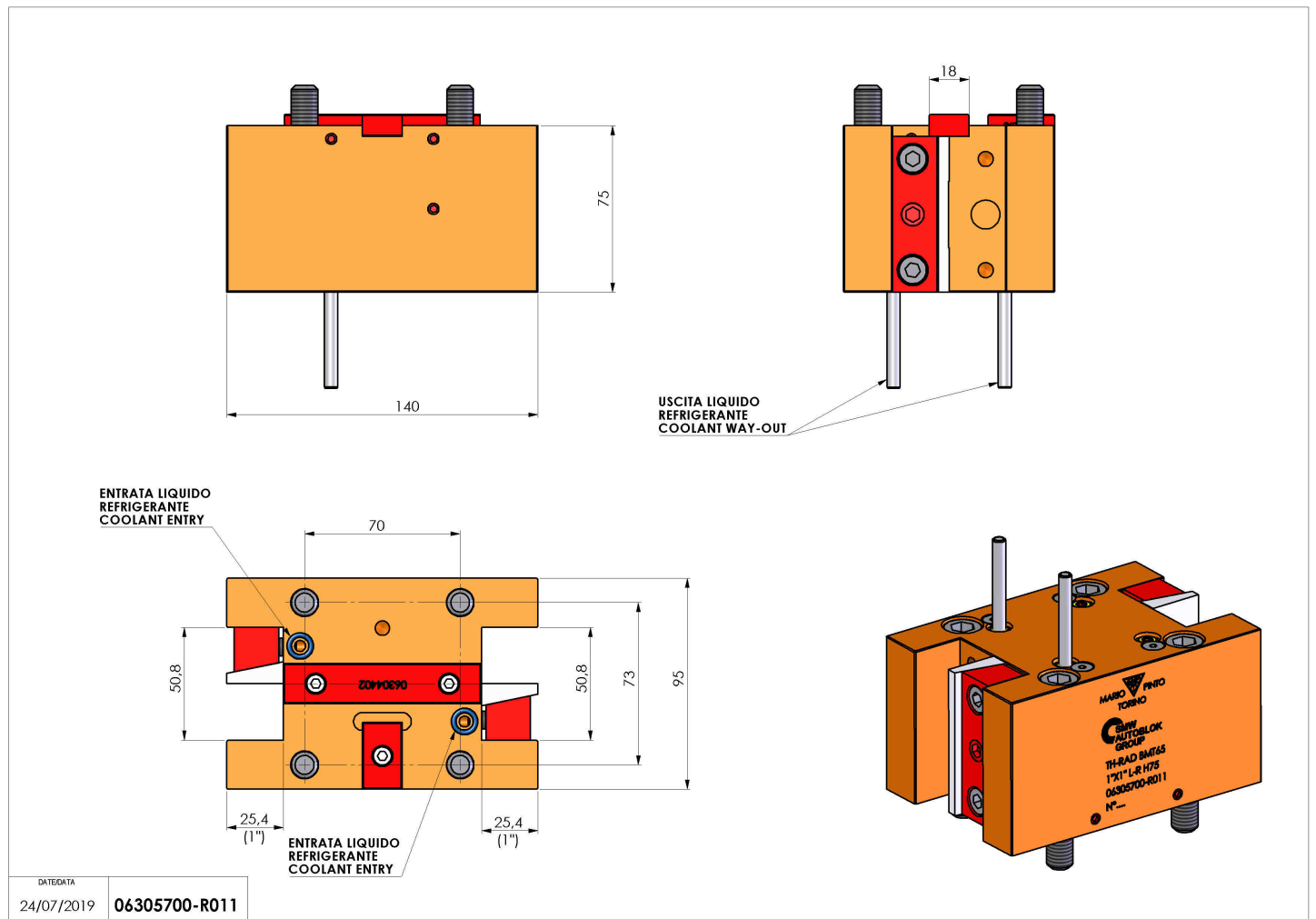

Subject to technical changes