

06304100 - TH-AX BMT65 1"X1" H95

Type	TH-AX Axial Tool holder
Mounting	BMT 65
Tool output	Axial Square Tool Holder 1"x 1"
Coolant	External coolant
H [mm]	95
Accessories	N.A.
Notes	N.A.
Mounting tips	Not suitable for every application, please check

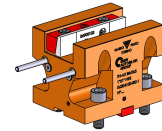

Always check live tool dimensions on the turret

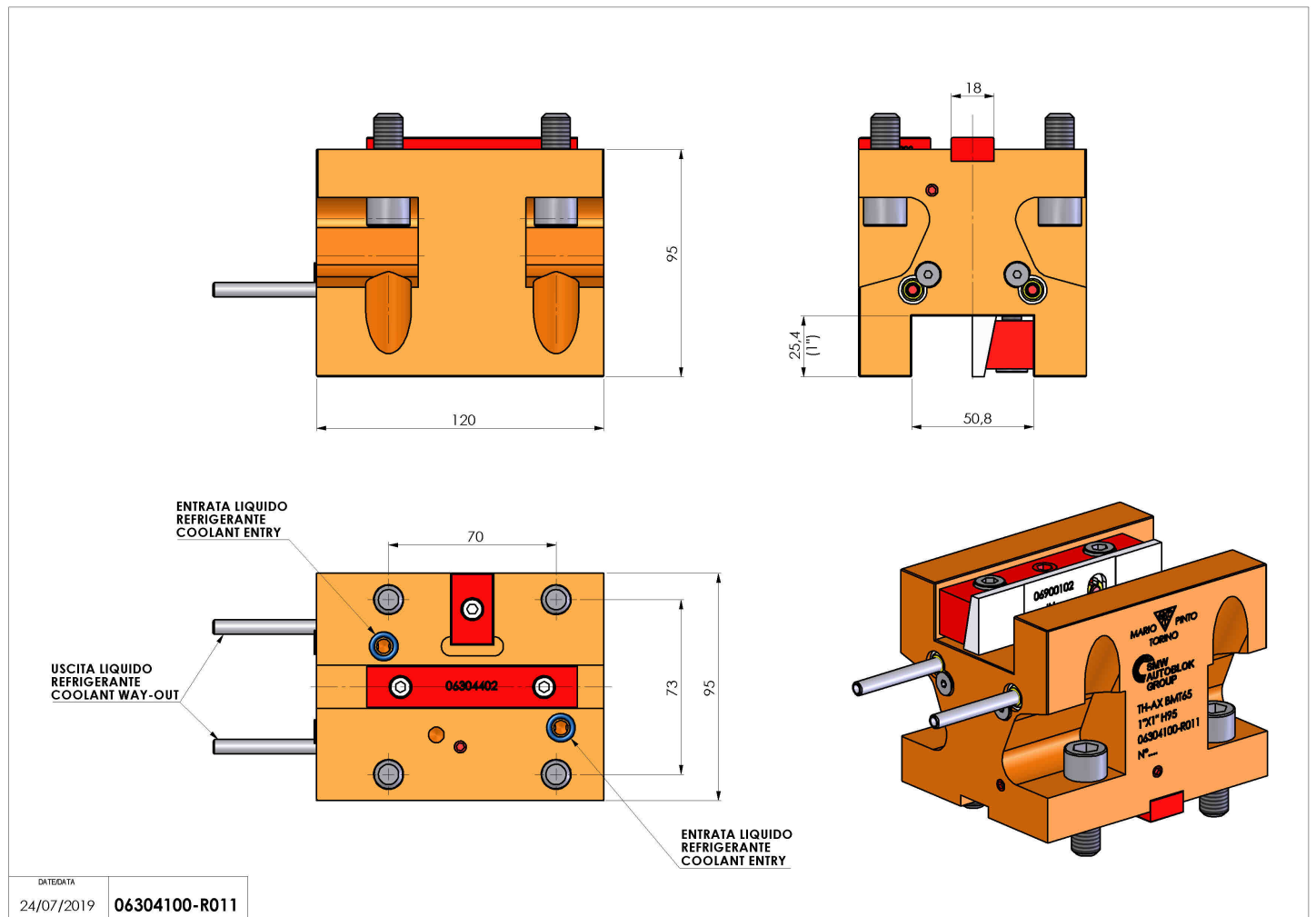

DATE/DATE	24/07/2019	06304100-R011
-----------	------------	---------------

Subject to technical changes