

## 06302200 - TH-RAD BMT55 25X25 H75

Type	TH-RAD Radial Tool holder
Mounting	BMT 55
Tool output	Radial Square Tool Holder 25x25
Coolant	External coolant
H [mm]	75
Accessories	N.A.
Notes	N.A.
Mounting tips	Not suitable for every application, please check

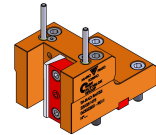

Always check live tool dimensions on the turret

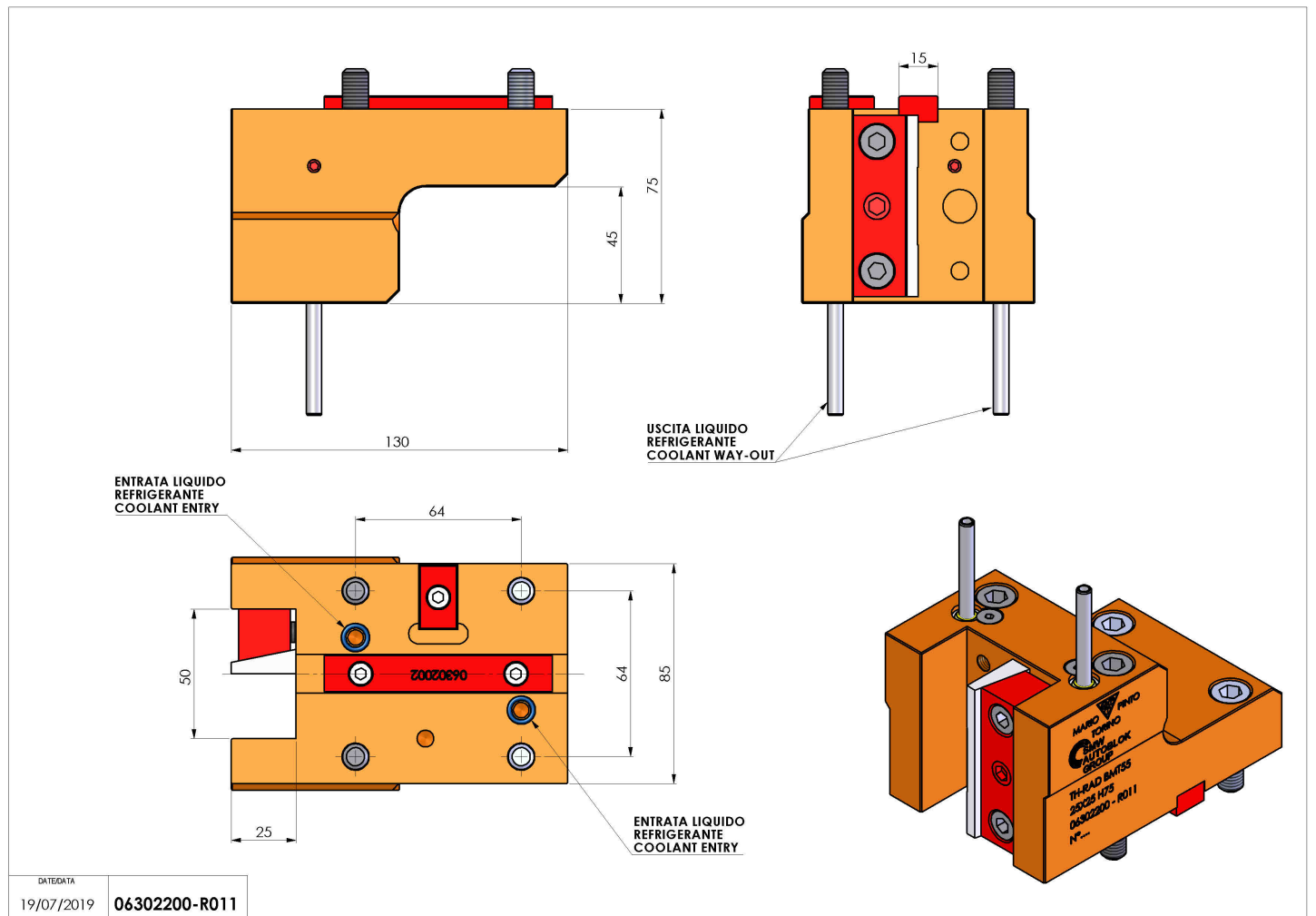

Subject to technical changes