

## 06257900 - TH-RAD D68 C40 OFS-52 RF H70

Type	TH-RAD Radial Tool holder
Mounting	CYLINDRICAL SHANK 68
Tool output	Polygonal shank C40 ISO 26623-1
Coolant	Internal coolant
H [mm]	70

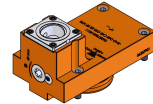

Accessories	N.A.
Notes	N.A.
Mounting tips	Not suitable for every application, please check

Always check live tool dimensions on the turret

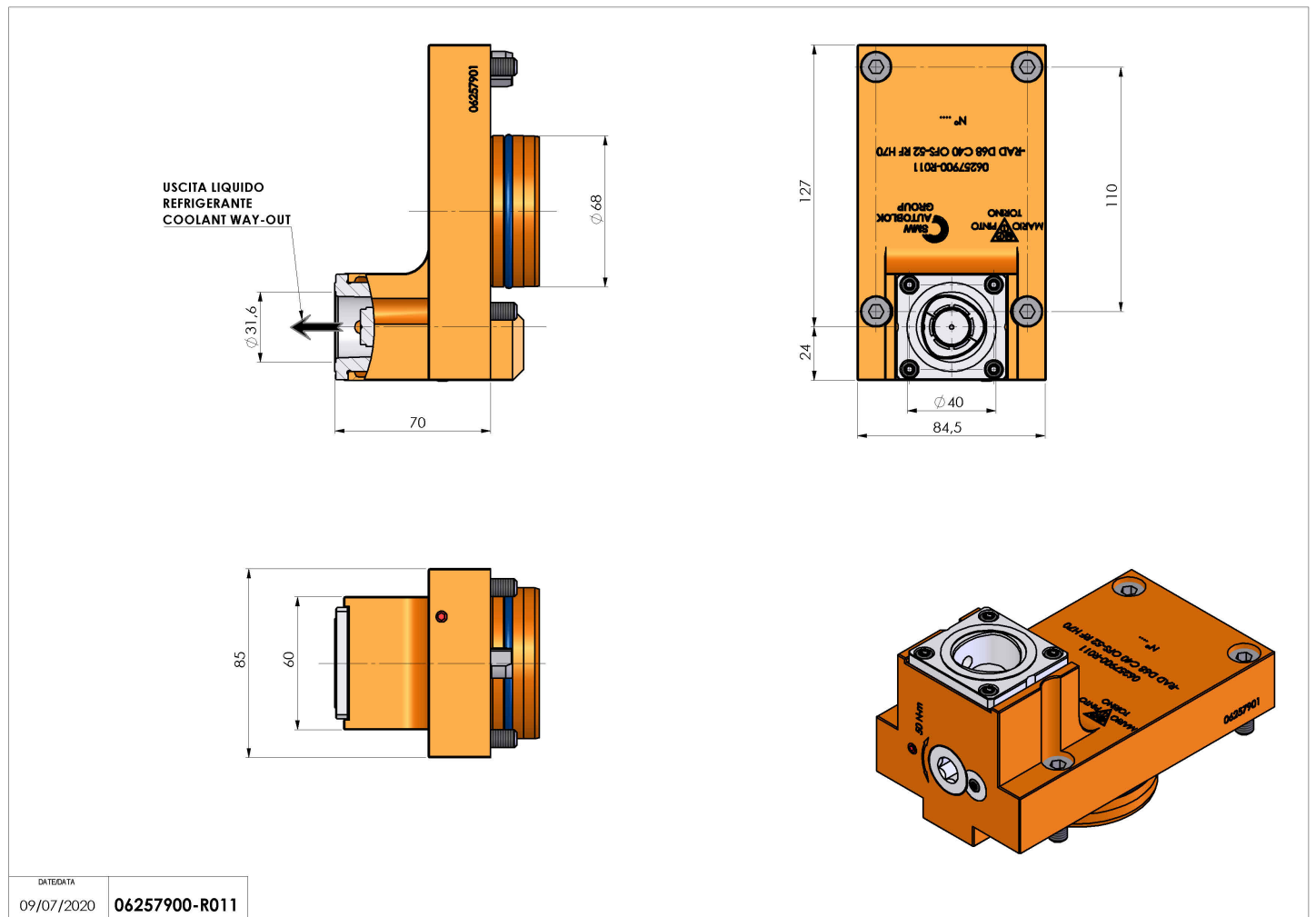

DATE/DATE	09/07/2020
06257900-R011	

Subject to technical changes