

06257800 - TH-AX D68 C50 RF H80

Type	TH-AX Axial Tool holder
Mounting	CYLINDRICAL SHANK 68
Tool output	Polygonal shank C50 ISO 26623-1
Coolant	Internal coolant
H [mm]	80
Accessories	N.A.
Notes	N.A.
Mounting tips	Not suitable for every application, please check

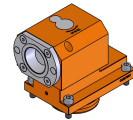

Always check live tool dimensions on the turret

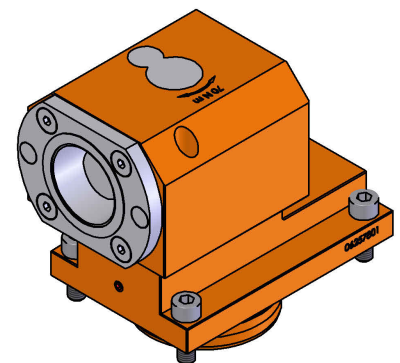
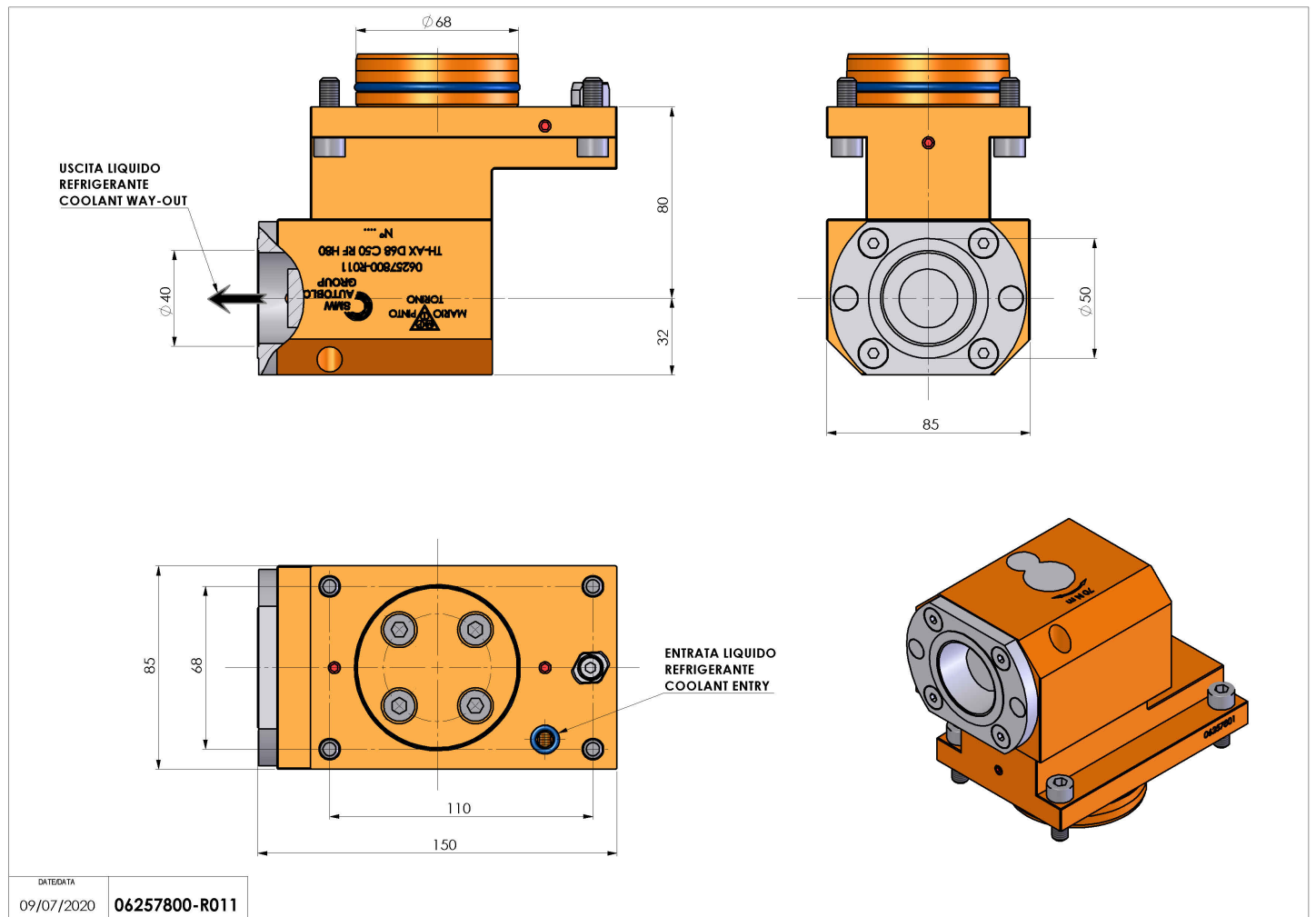

Subject to technical changes