

06256800 - TH-AX D80 C50 RF H120

Type	TH-AX Axial Tool holder
Mounting	CYLINDRICAL SHANK 80
Tool output	Polygonal shank C50 ISO 26623-1
Coolant	Internal coolant
H [mm]	120

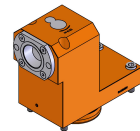

Accessories	N.A.
Notes	N.A.
Mounting tips	Not suitable for every application, please check

Always check live tool dimensions on the turret

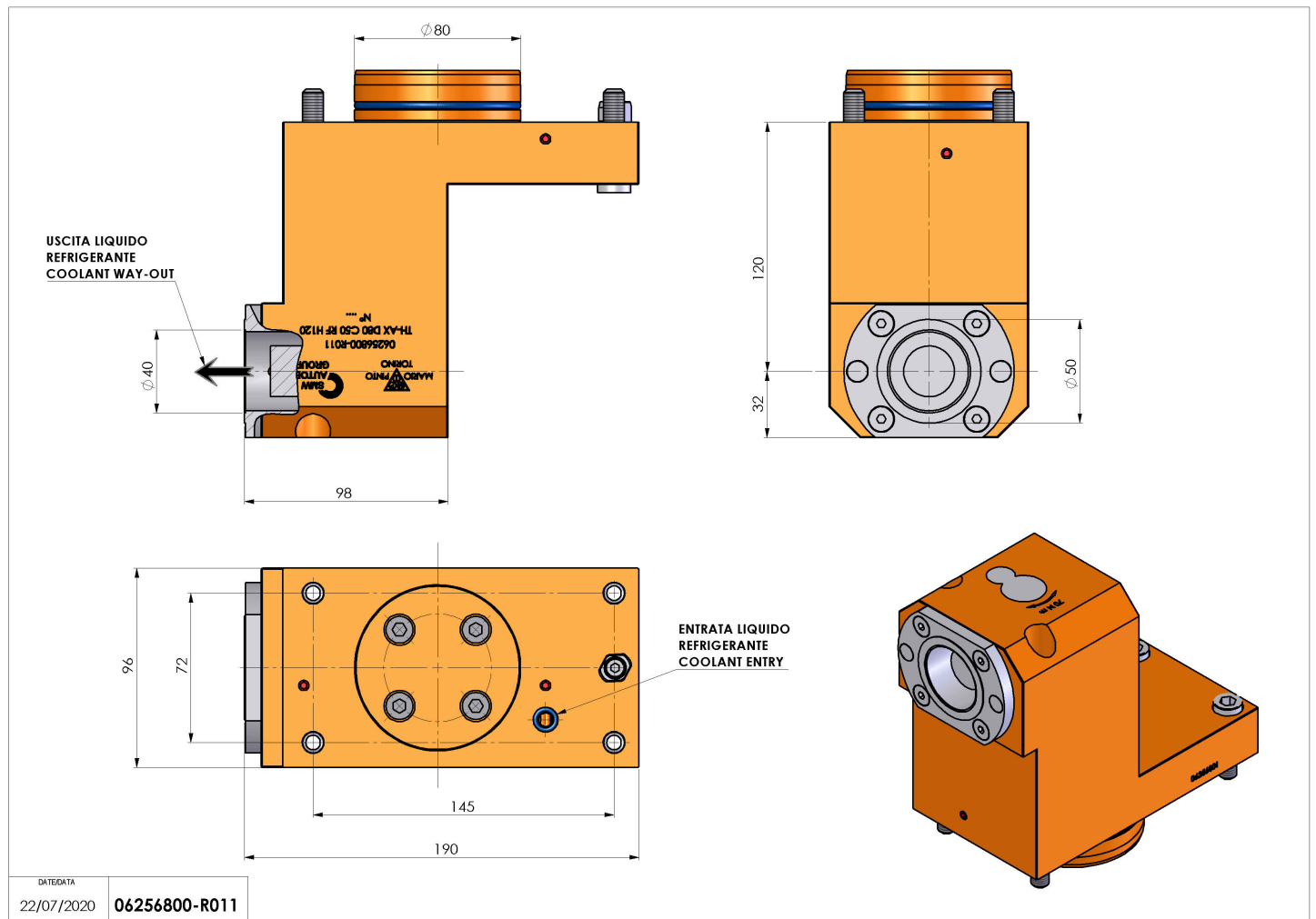

Subject to technical changes