

06256100 - TH-RAD D80 H110 DX-SX MZ

Type	TH-RAD Radial Tool holder
Mounting	CYLINDRICAL SHANK 80
Tool output	Radial Square Tool Holder 25x25
Coolant	External coolant
H [mm]	110

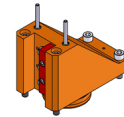

Accessories	N.A.
Notes	N.A.
Mounting tips	Not suitable for every application, please check

Always check live tool dimensions on the turret

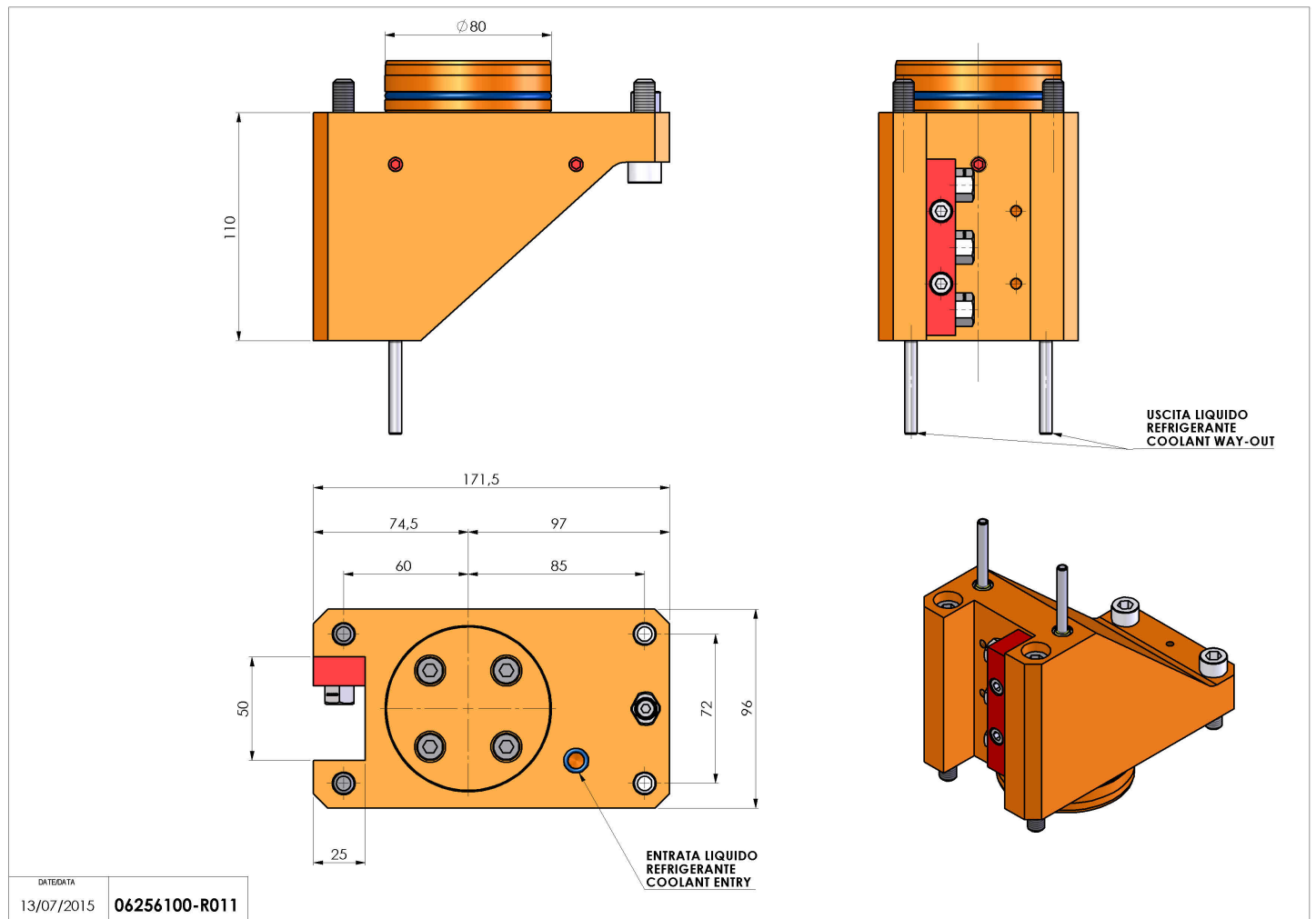

Subject to technical changes