

06255400 - TH-RAD D68 H80 UT32X32 DX-SXMZ

Type	TH-RAD Radial Tool holder
Mounting	CYLINDRICAL SHANK 68
Tool output	Radial Square Tool Holder 32x32
Coolant	External coolant
H [mm]	80

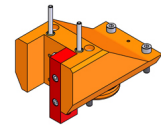

Accessories	N.A.
Notes	N.A.
Mounting tips	Not suitable for every application, please check

Always check live tool dimensions on the turret

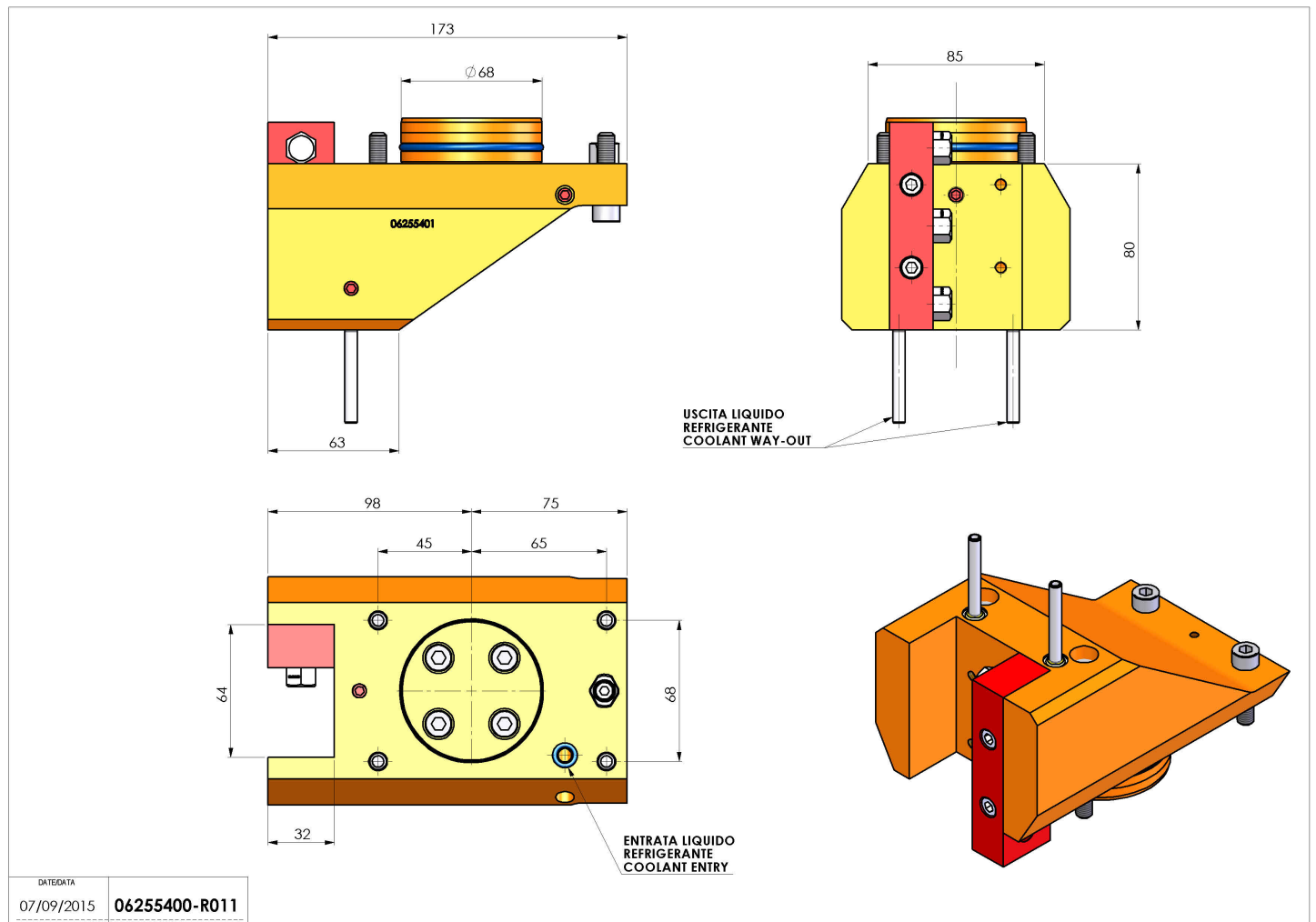

Subject to technical changes