

## 06255000 - TH-BRB D68 D40 H95 MZ

<b>Type</b>	TH-BRB Boring bar holder
<b>Mounting</b>	CYLINDRICAL SHANK 68
<b>Tool output</b>	Boring Bar Holder 40
<b>Coolant</b>	External / Internal coolant
<b>H [mm]</b>	95
<b>Accessories</b>	N.A.
<b>Notes</b>	N.A.
<b>Mounting tips</b>	Not suitable for every application, please check

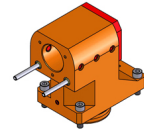

Always check live tool dimensions on the turret

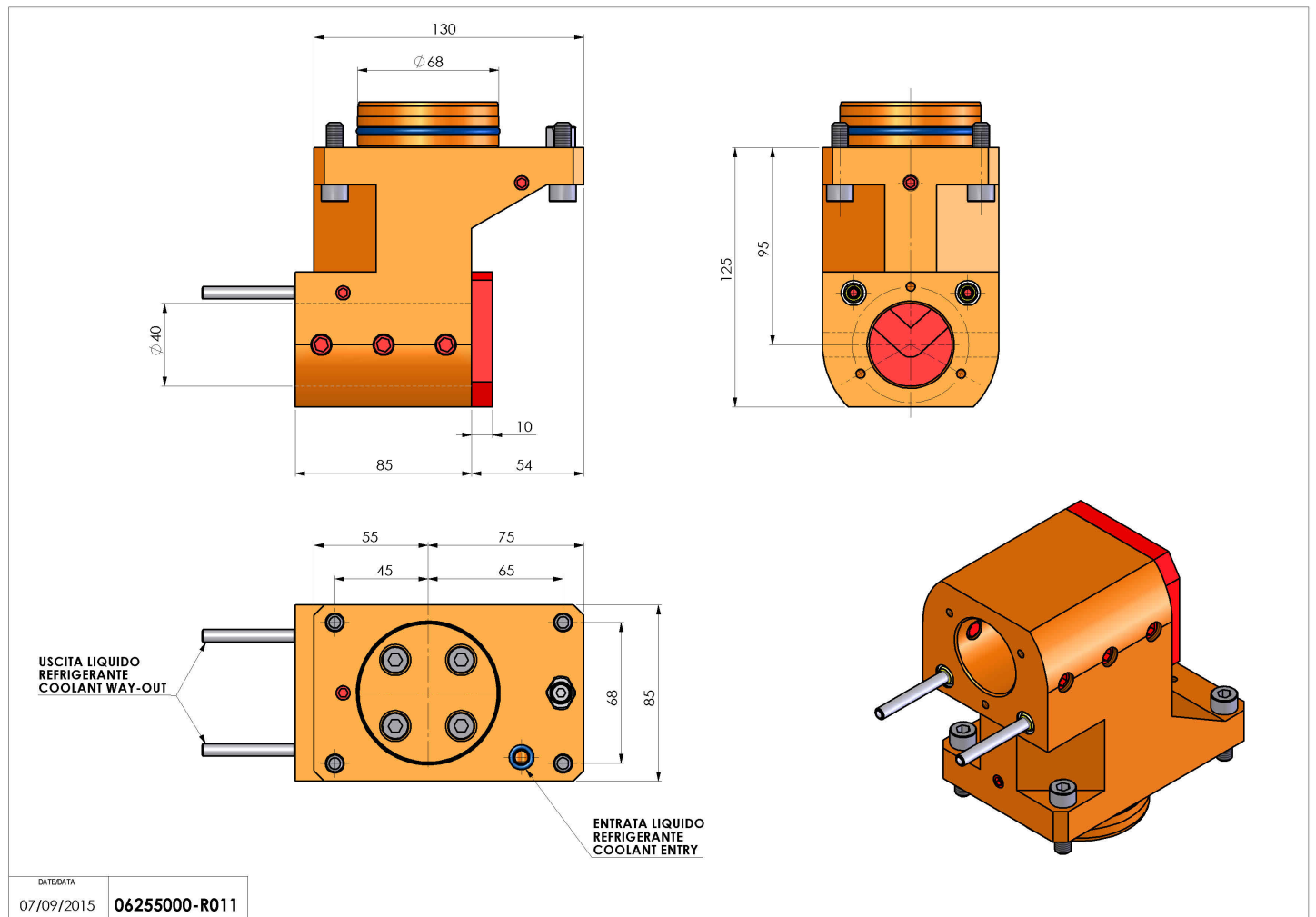

Subject to technical changes