

# 06250600 - TH-RAD VDI40 H110 L65 DX-SX MZ

Type	TH-RAD Radial Tool holder
Mounting	VDI 40
Tool output	Radial Square Tool Holder 20x20
Coolant	External coolant
H [mm]	110

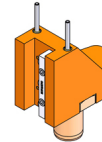

Accessories	N.A.
Notes	N.A.
Mounting tips	Not suitable for every application, please check

**ATTENZIONE: VERIFICARE L'ORIENTAMENTO DELLA DENTATURA VDI**

Always check live tool dimensions on the turret

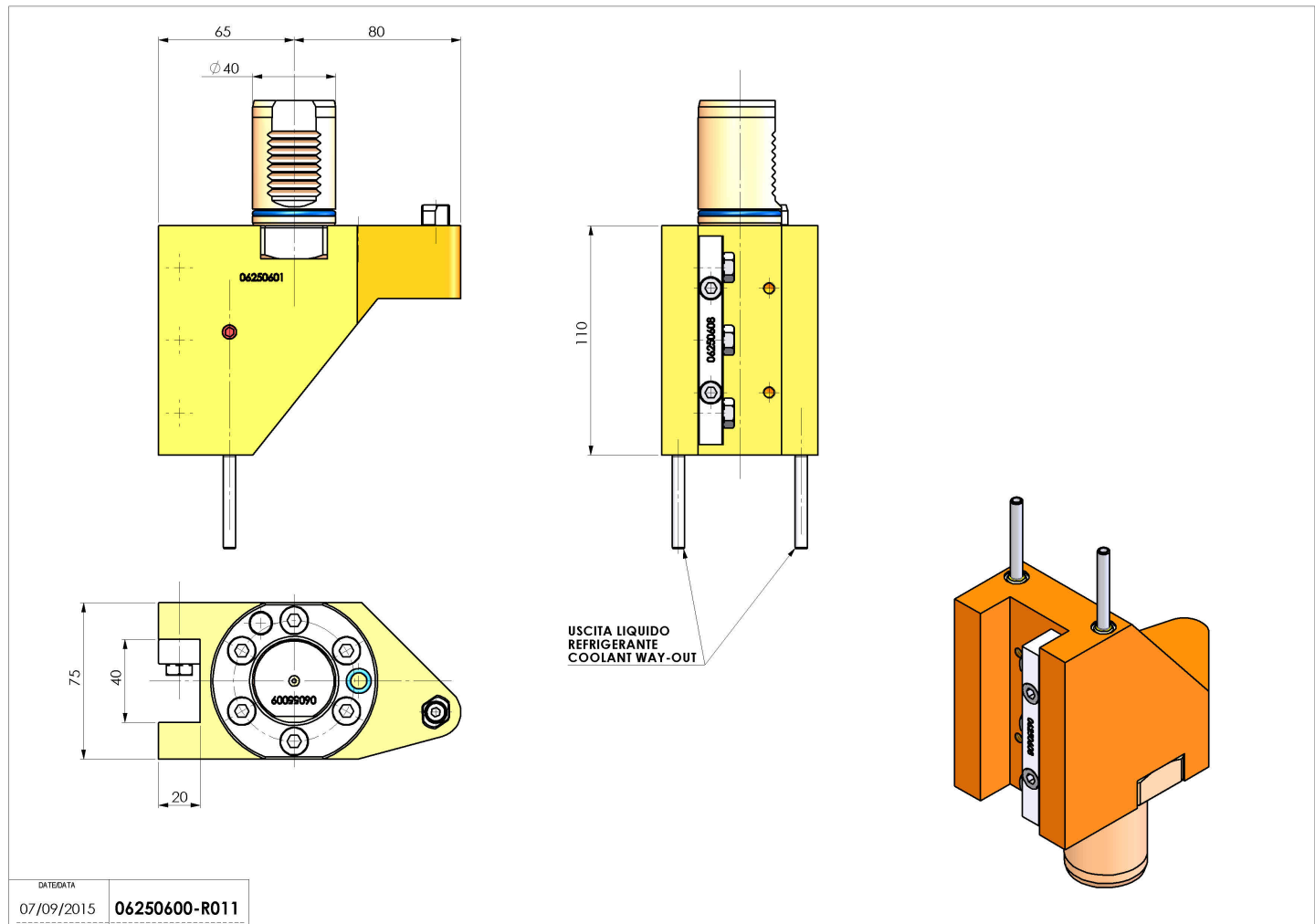

DATE/DATE	07/09/2015	06250600-R011
-----------	------------	---------------

Subject to technical changes