

## 06063200 - TH-AX D60 Q25 H70

<b>Type</b>	TH-AX Axial Tool holder
<b>Mounting</b>	CYLINDRICAL SHANK 60
<b>Tool output</b>	Axial Square Tool Holder 25x25
<b>Coolant</b>	External coolant
<b>H [mm]</b>	70
<b>Accessories</b>	N.A.
<b>Notes</b>	N.A.
<b>Mounting tips</b>	Not suitable for every application, please check

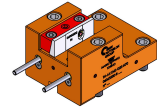

Always check live tool dimensions on the turret

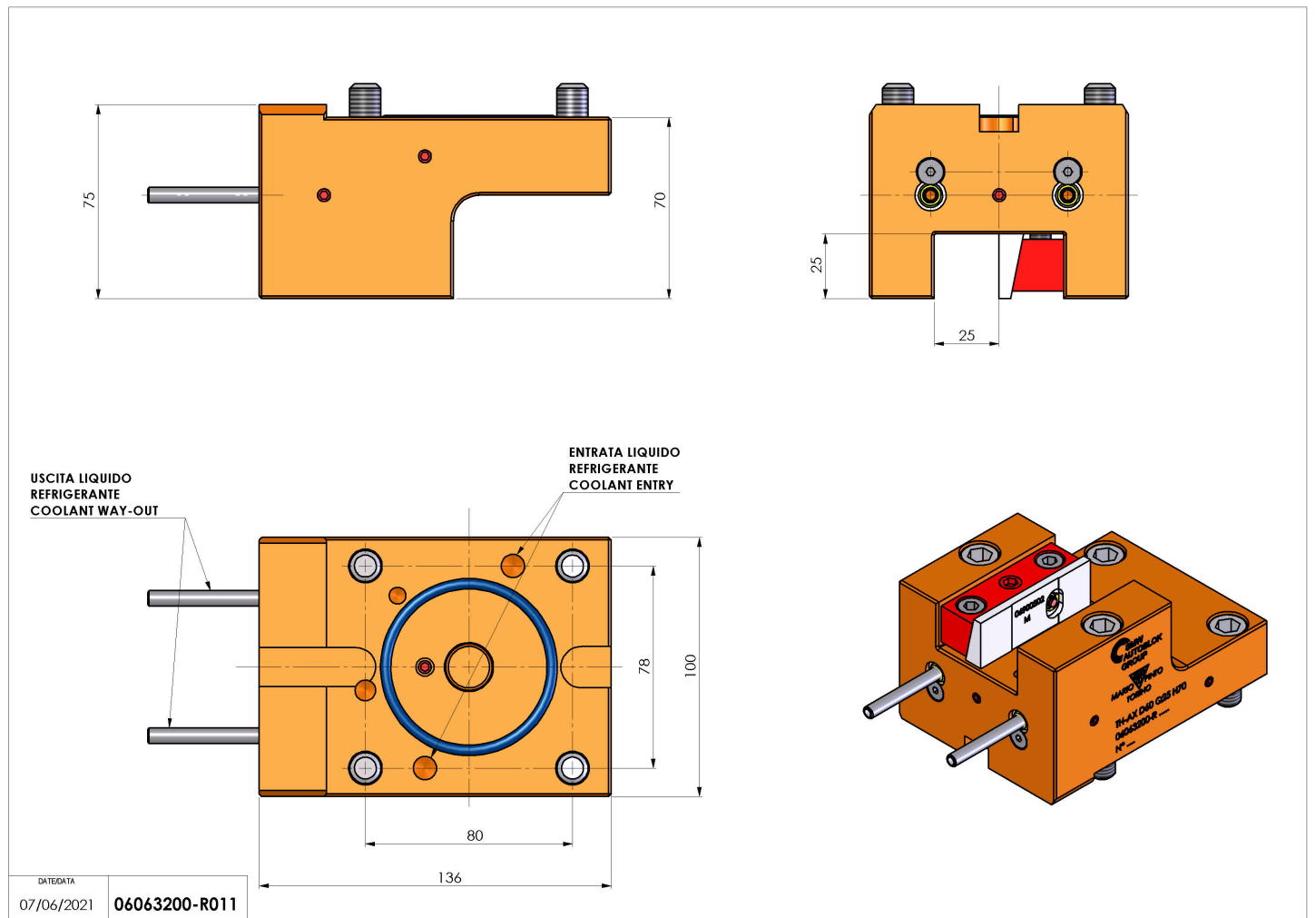

Subject to technical changes