

06059600 - TH-AX VDI40 C40 RF H140

Type	TH-AX Axial Tool holder
Mounting	VDI 40
Tool output	Polygonal shank C40 ISO 26623-1
Coolant	Internal coolant
H [mm]	140

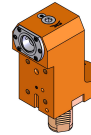

Accessories	N.A.
Notes	N.A.
Mounting tips	Not suitable for every application, please check

ATTENZIONE: VERIFICARE L'ORIENTAMENTO DELLA DENTATURA VDI

Always check live tool dimensions on the turret

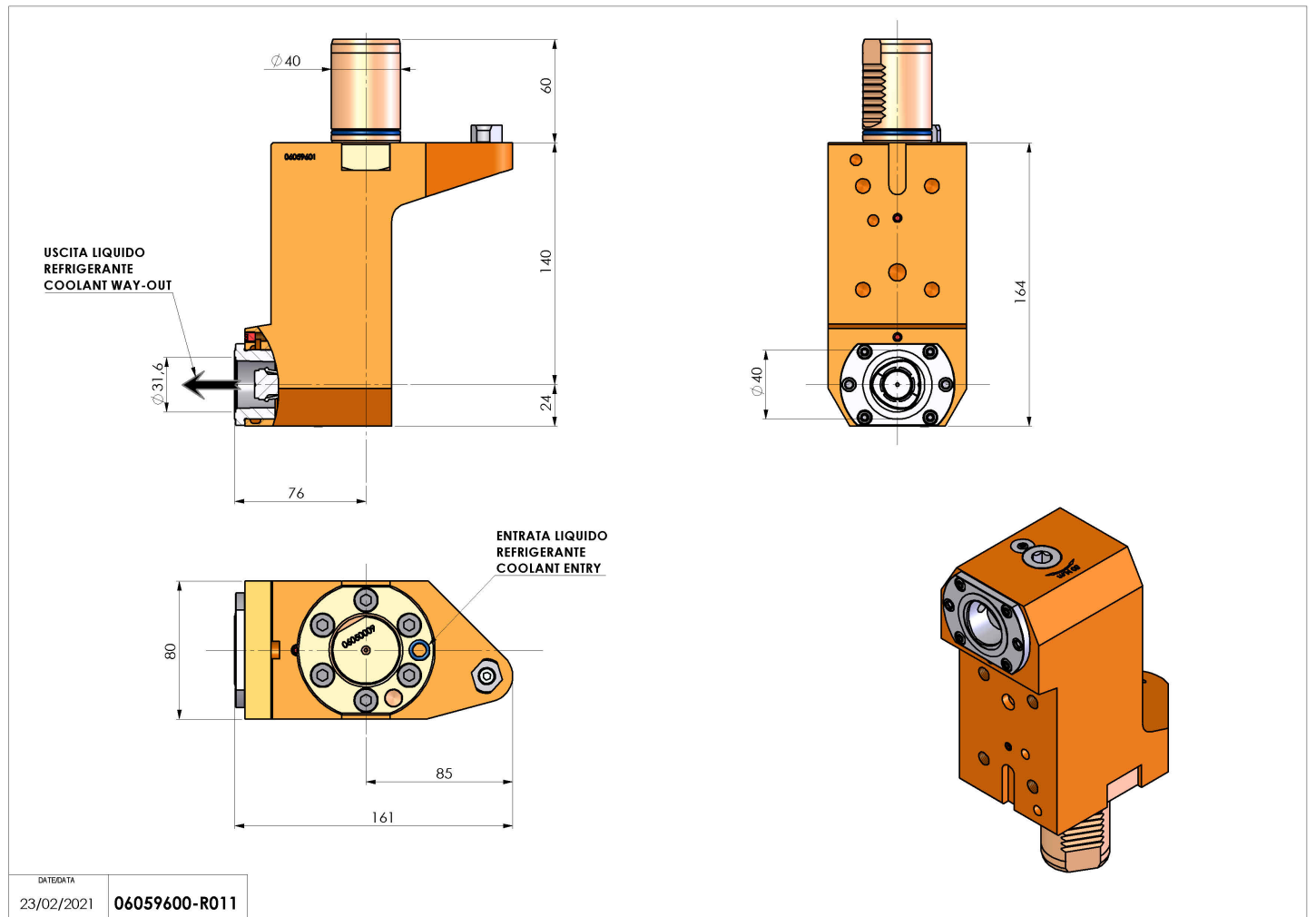

DATE/DATE	06059600-R011
23/02/2021	

Subject to technical changes