

06055100 - TH-BRB VDI40 D32 H130 OFS RFMZ

Type	TH-BRB Boring bar holder
Mounting	VDI 40
Tool output	Boring Bar Holder 32
Coolant	External / Internal coolant
H [mm]	130

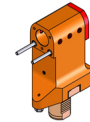

Accessories	N.A.
Notes	N.A.
Mounting tips	Not suitable for every application, please check

ATTENZIONE: VERIFICARE L'ORIENTAMENTO DELLA DENTATURA VDI

Always check live tool dimensions on the turret

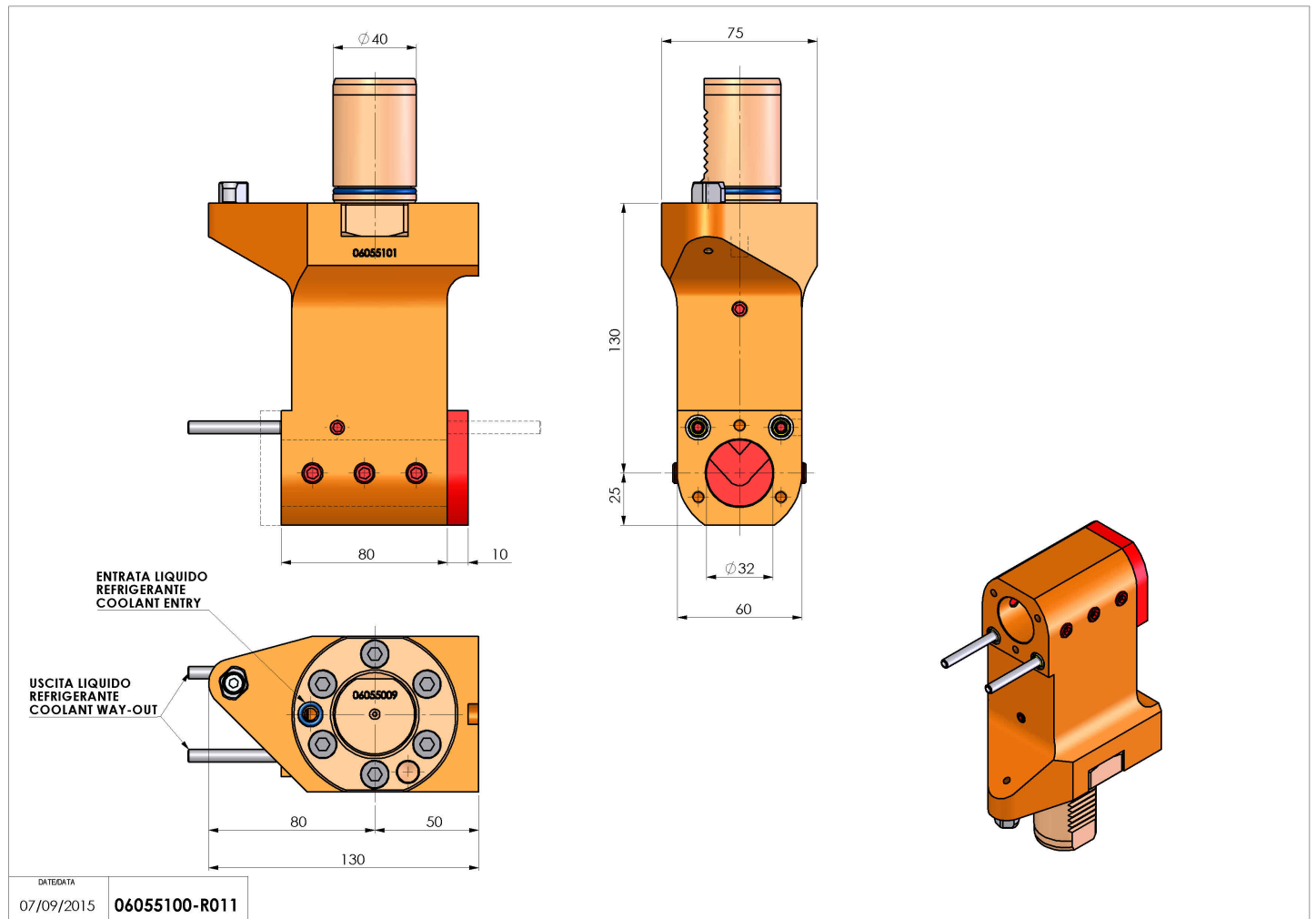

Subject to technical changes