

# 06054500 - TH-BRB VDI50 D60H155L210 RF MZ

<b>Type</b>	TH-BRB Boring bar holder
<b>Mounting</b>	VDI 50
<b>Tool output</b>	Boring Bar Holder 60
<b>Coolant</b>	External / Internal coolant
<b>H [mm]</b>	155

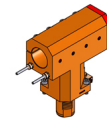

<b>Accessories</b>	N.A.
<b>Notes</b>	N.A.
<b>Mounting tips</b>	Not suitable for every application, please check

**ATTENZIONE: VERIFICARE L'ORIENTAMENTO DELLA DENTATURA VDI**

Always check live tool dimensions on the turret

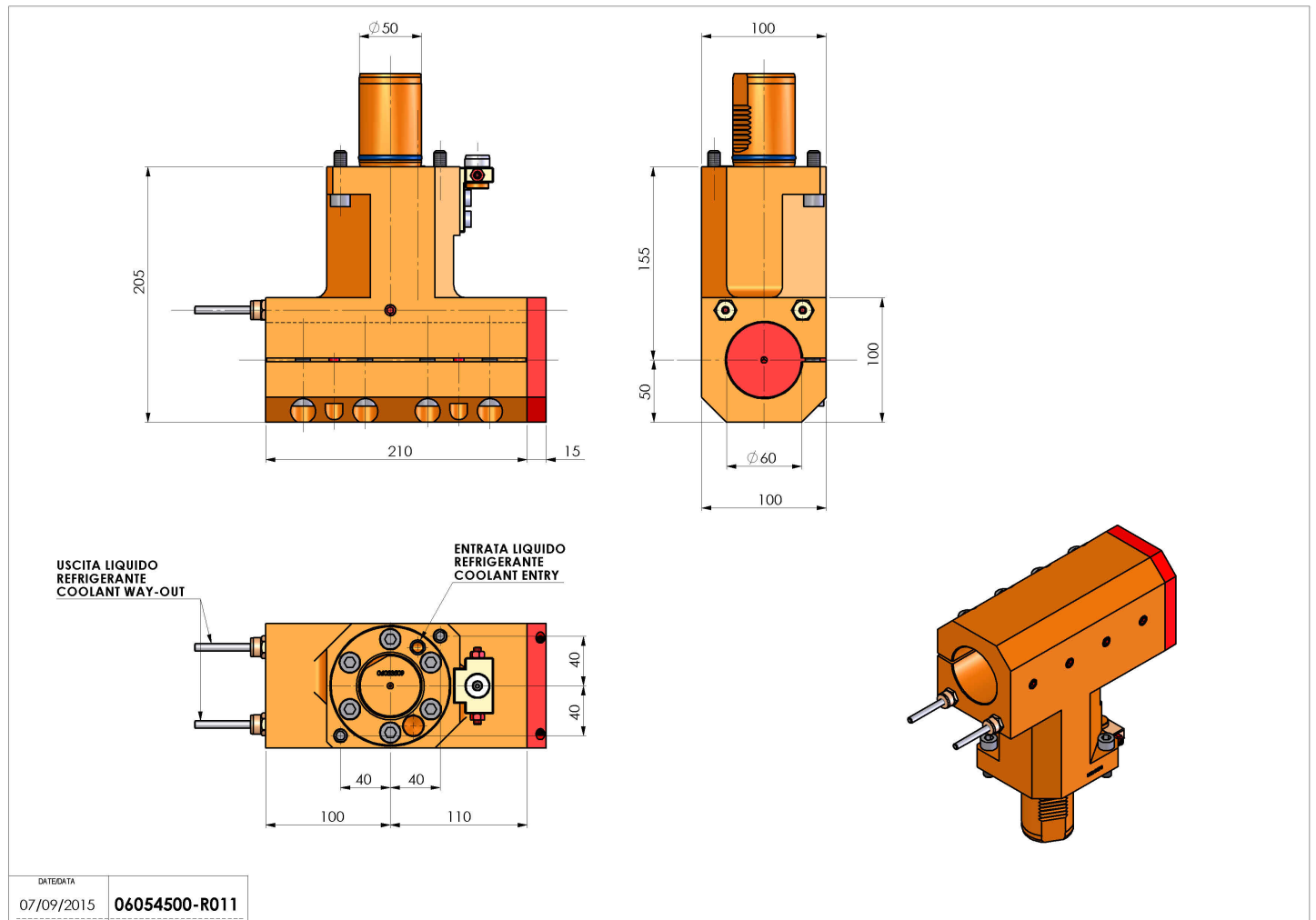

Subject to technical changes