

## 06051400 - TH-BRB VDI40 D50 H135L200 RFMZ

Type	TH-BRB Boring bar holder
Mounting	VDI 40
Tool output	Boring Bar Holder 50
Coolant	External / Internal coolant
H [mm]	135

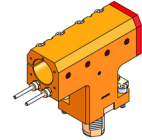

Accessories	N.A.
Notes	N.A.
Mounting tips	Not suitable for every application, please check

**ATTENZIONE: VERIFICARE L'ORIENTAMENTO DELLA DENTATURA VDI**

Always check live tool dimensions on the turret

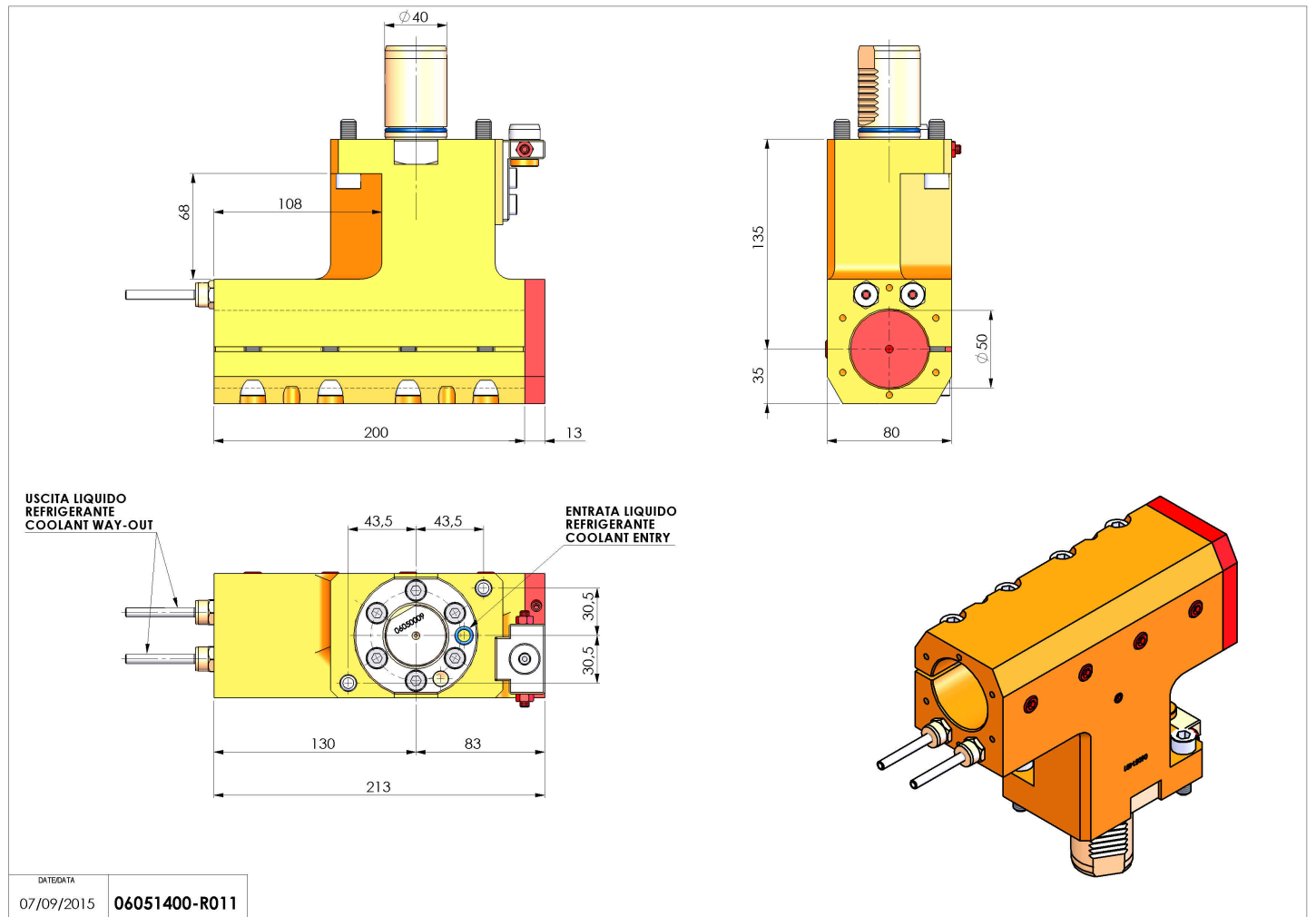

Subject to technical changes