

06046000 - TH-AX D40 C40 RF H100

Type	TH-AX Axial Tool holder
Mounting	CYLINDRICAL SHANK 40
Tool output	Polygonal shank C40 ISO 26623-1
Coolant	Internal coolant
H [mm]	100

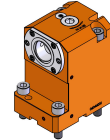

Accessories	N.A.
Notes	N.A.
Mounting tips	Not suitable for every application, please check

Always check live tool dimensions on the turret

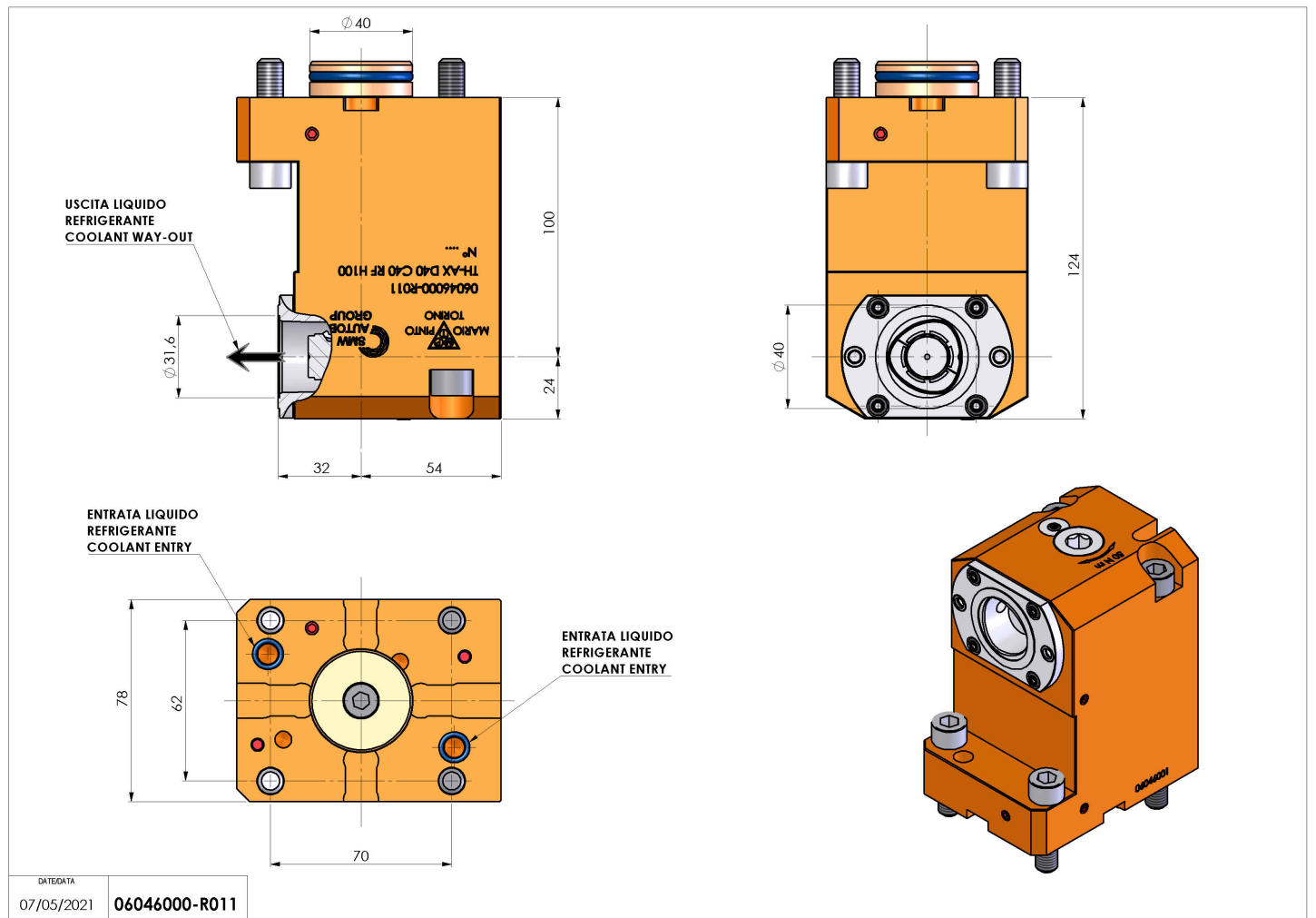

Subject to technical changes