

06043500 - TH-BRB D75 D40 HRF H80

Type	TH-BRB Boring bar holder
Mounting	CYLINDRICAL SHANK 75
Tool output	Boring Bar Holder 40
Coolant	External / Internal coolant
H [mm]	80

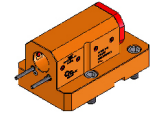

Accessories	N.A.
Notes	N.A.
Mounting tips	Not suitable for every application, please check

Always check live tool dimensions on the turret

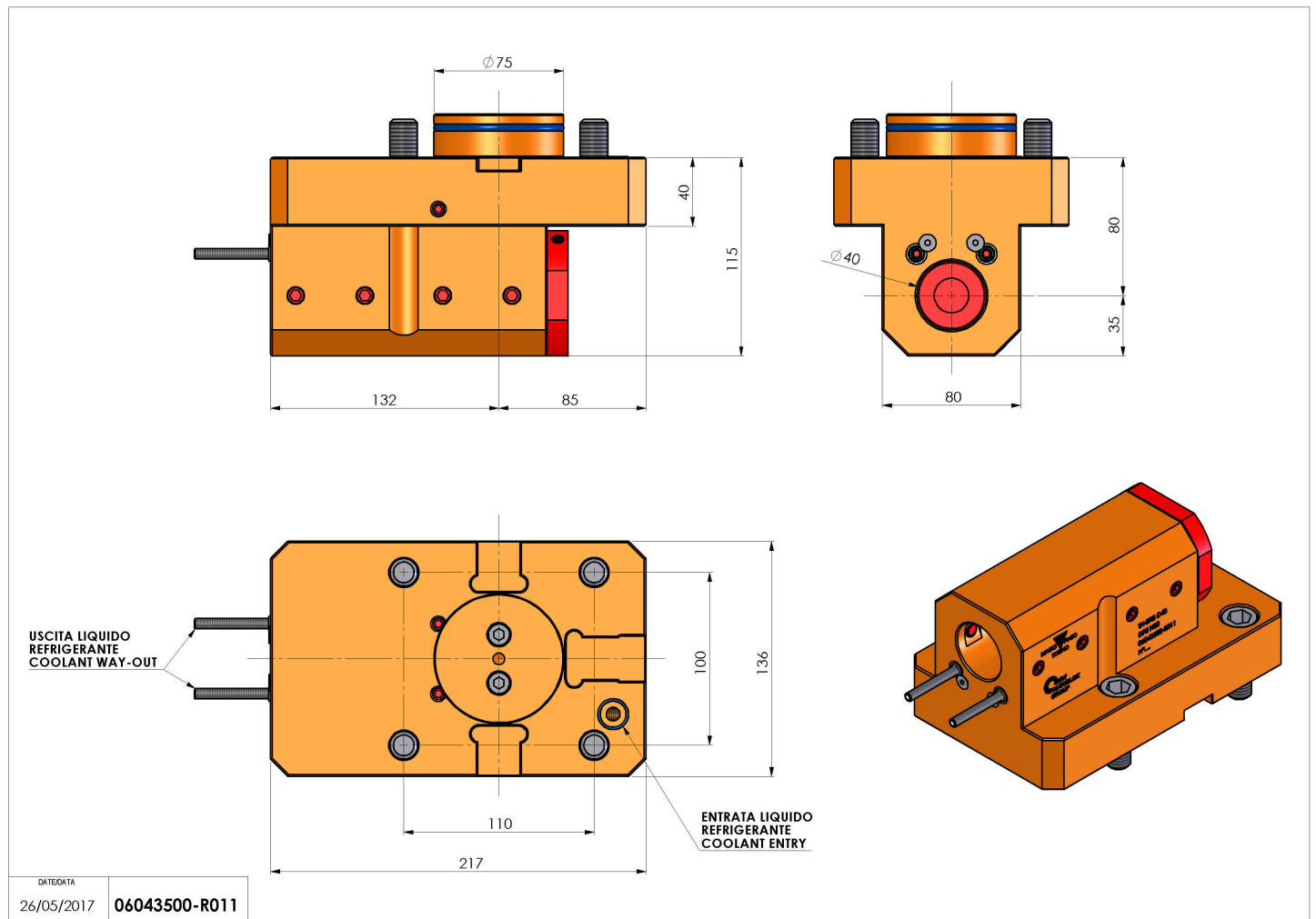

Subject to technical changes