

06030800 - TH-BRB D55 D40 H90

Type	TH-BRB Boring bar holder
Mounting	CYLINDRICAL SHANK 55
Tool output	Boring Bar Holder 40
Coolant	External / Internal coolant
H [mm]	90

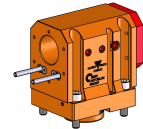

Accessories	N.A.
Notes	N.A.
Mounting tips	Not suitable for every application, please check

Always check live tool dimensions on the turret

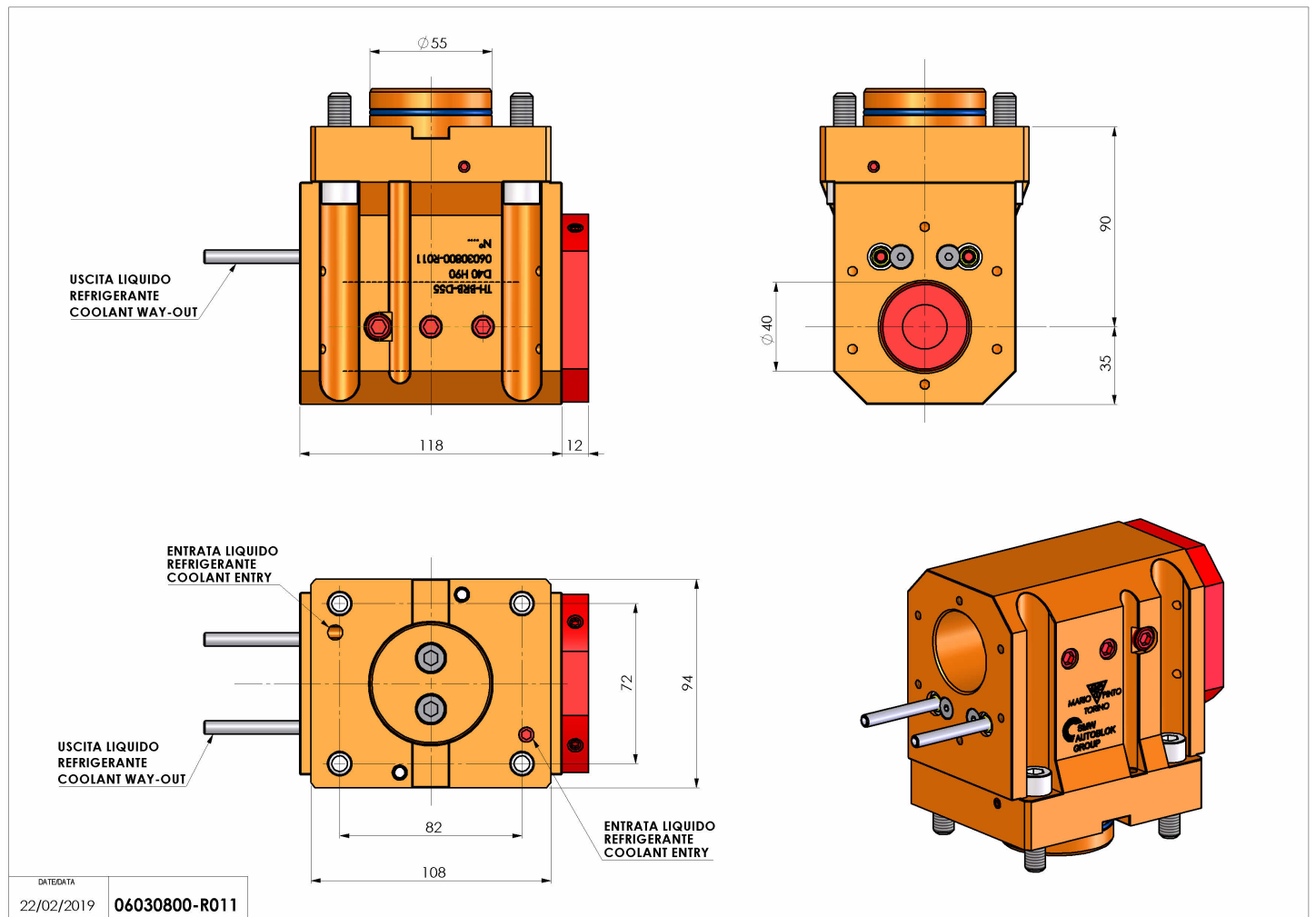

Subject to technical changes