

06014400 - TH-RAD D65 Q25 H70

Type	TH-RAD Radial Tool holder
Mounting	CYLINDRICAL SHANK 65
Tool output	Radial Square Tool Holder 25x25
Coolant	External coolant
H [mm]	70
Accessories	N.A.
Notes	N.A.
Mounting tips	Not suitable for every application, please check

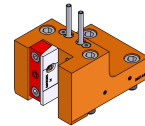

Always check live tool dimensions on the turret

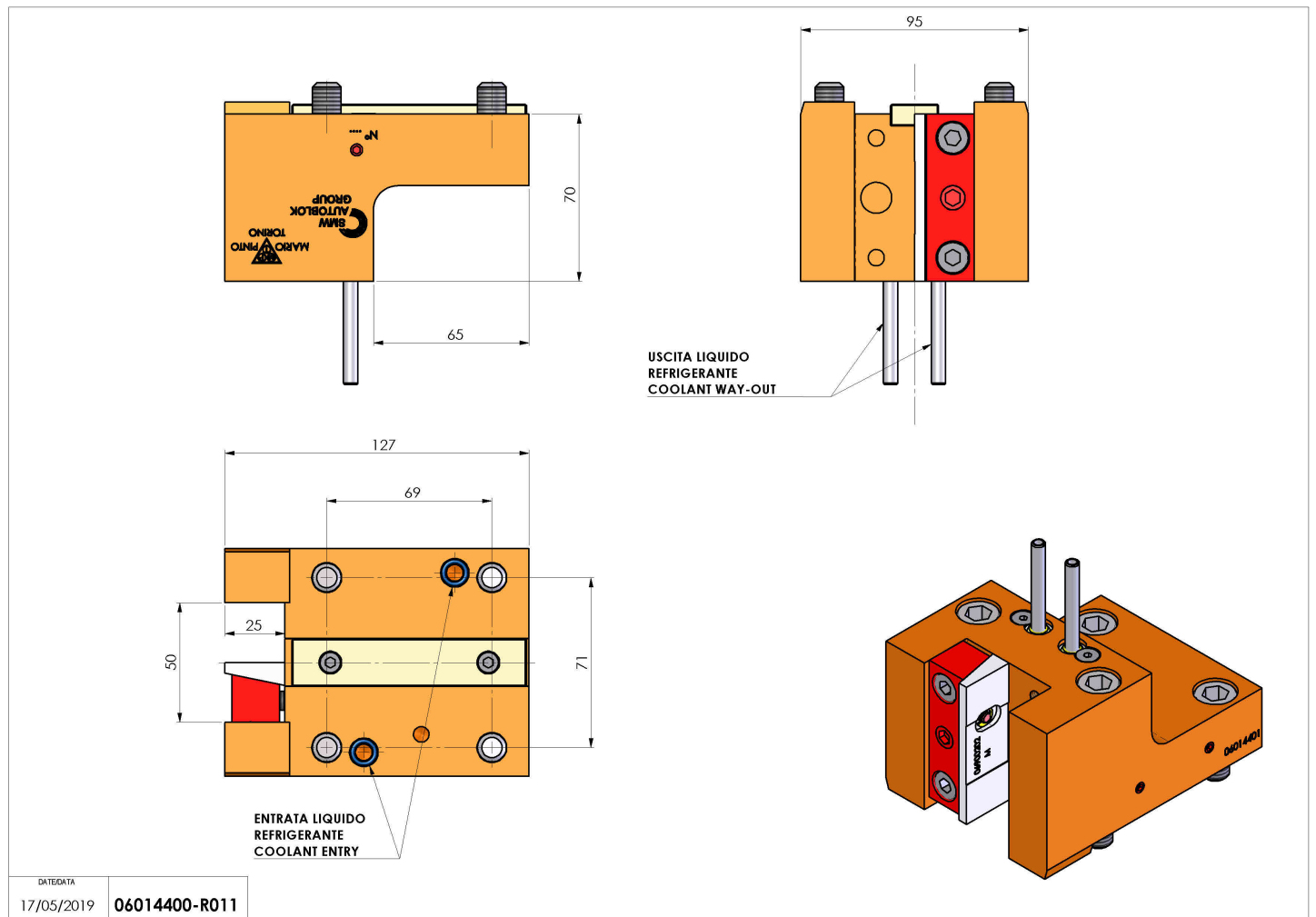

Subject to technical changes