

06010100 - TH-RAD D44 DP Q20 H55

Type	TH-RAD Radial Tool holder
Mounting	CYLINDRICAL SHANK 44
Tool output	Radial Square Tool Holder 20x20
Coolant	External coolant
H [mm]	55

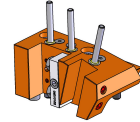

Accessories	N.A.
Notes	N.A.
Mounting tips	Not suitable for every application, please check

Always check live tool dimensions on the turret

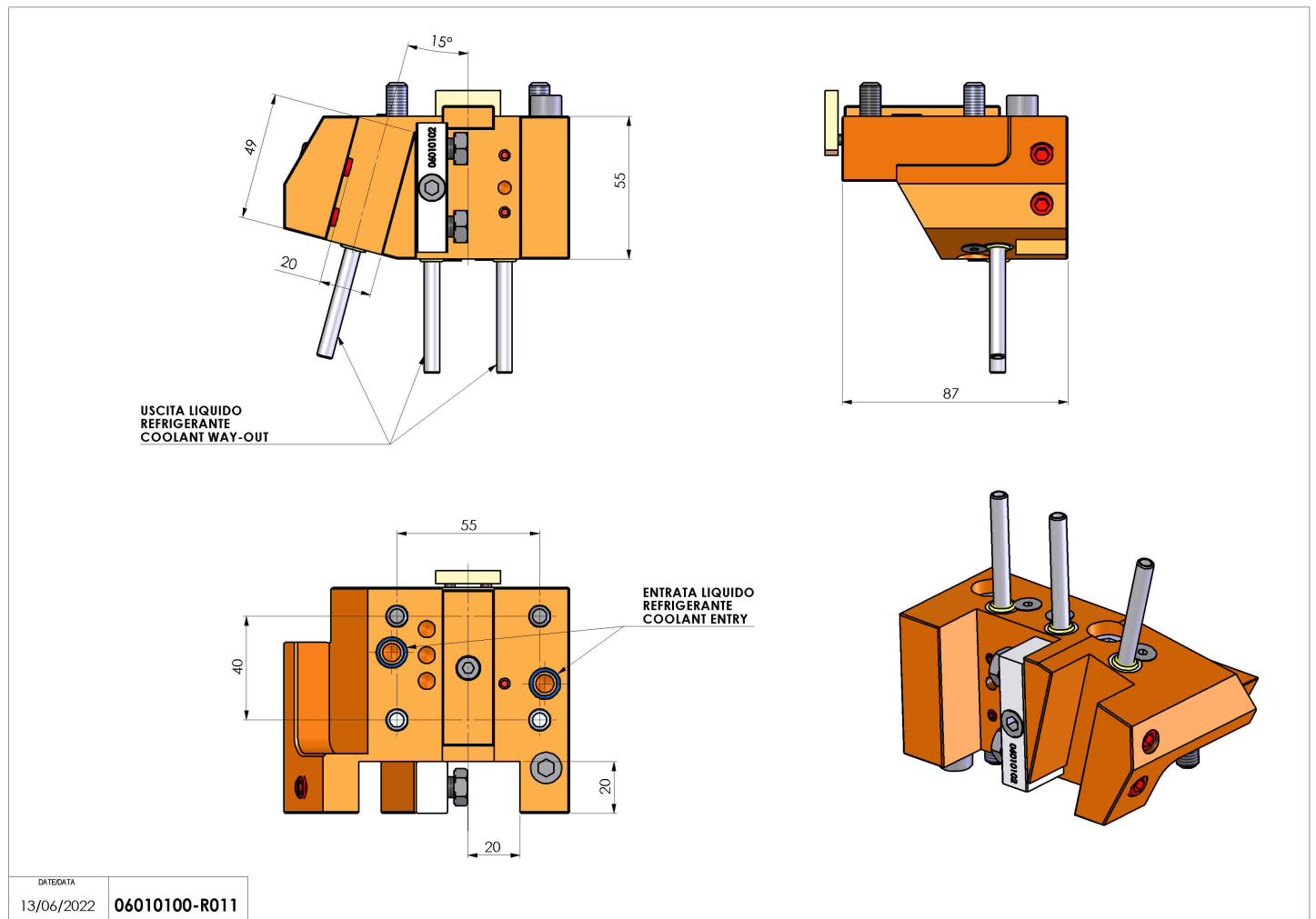

Subject to technical changes