

05402400 - LT-T D60 ER20F H70-151

Type	LT-T Tool holder tiltable
Mounting	CYLINDRICAL SHANK 60
Tool output	Collet nut ER 20 F - internal nut
Coolant	External coolant
Direction of rotation	r1 r2
Max speed [rpm]	6000
Max torque [Nm]	20
Ratio	1:1
H [mm]	70-151
Accessories	N.A.
Notes	N.A.
Mounting tips	Not suitable for every application, please check

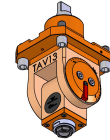

Always check live tool dimensions on the turret

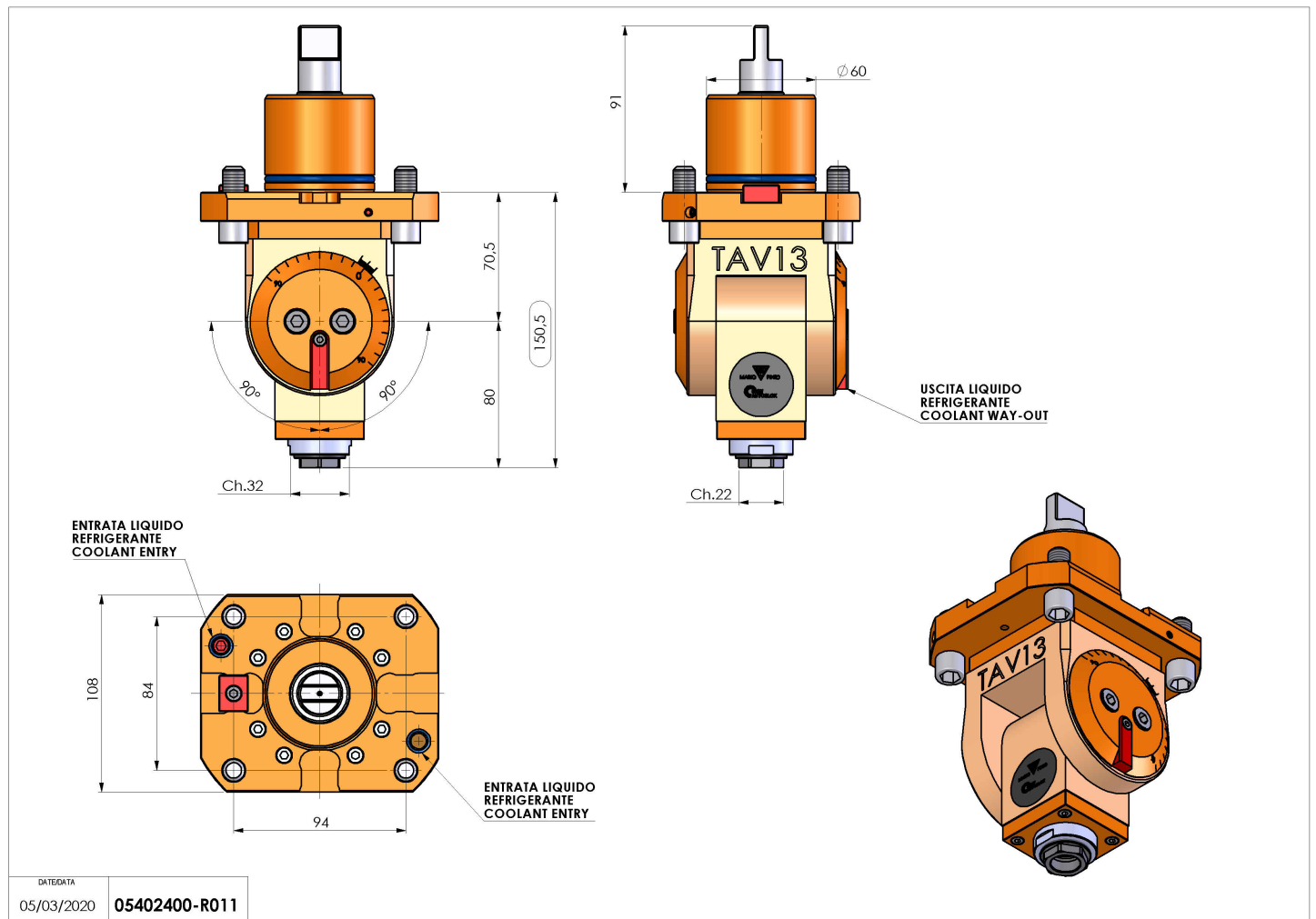

DATE/DATE: 05/03/2020
 05402400-R011

Subject to technical changes