

05401800 - LT-A D60 ER40F LR HRF H90

Type	LT-A Tool holder angle 90°
Mounting	CYLINDRICAL SHANK 60
Tool output	Collet nut ER 40 F - internal nut
Coolant	HP Internal coolant
Direction of rotation	r1 r2
Max speed [rpm]	6000
Max torque [Nm]	70
Ratio	1:1
H [mm]	90
Max pressure [bar]	80
Accessories	N.A.
Notes	N.A.
Mounting tips	Not suitable for every application, please check

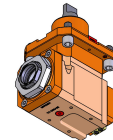

Always check live tool dimensions on the turret

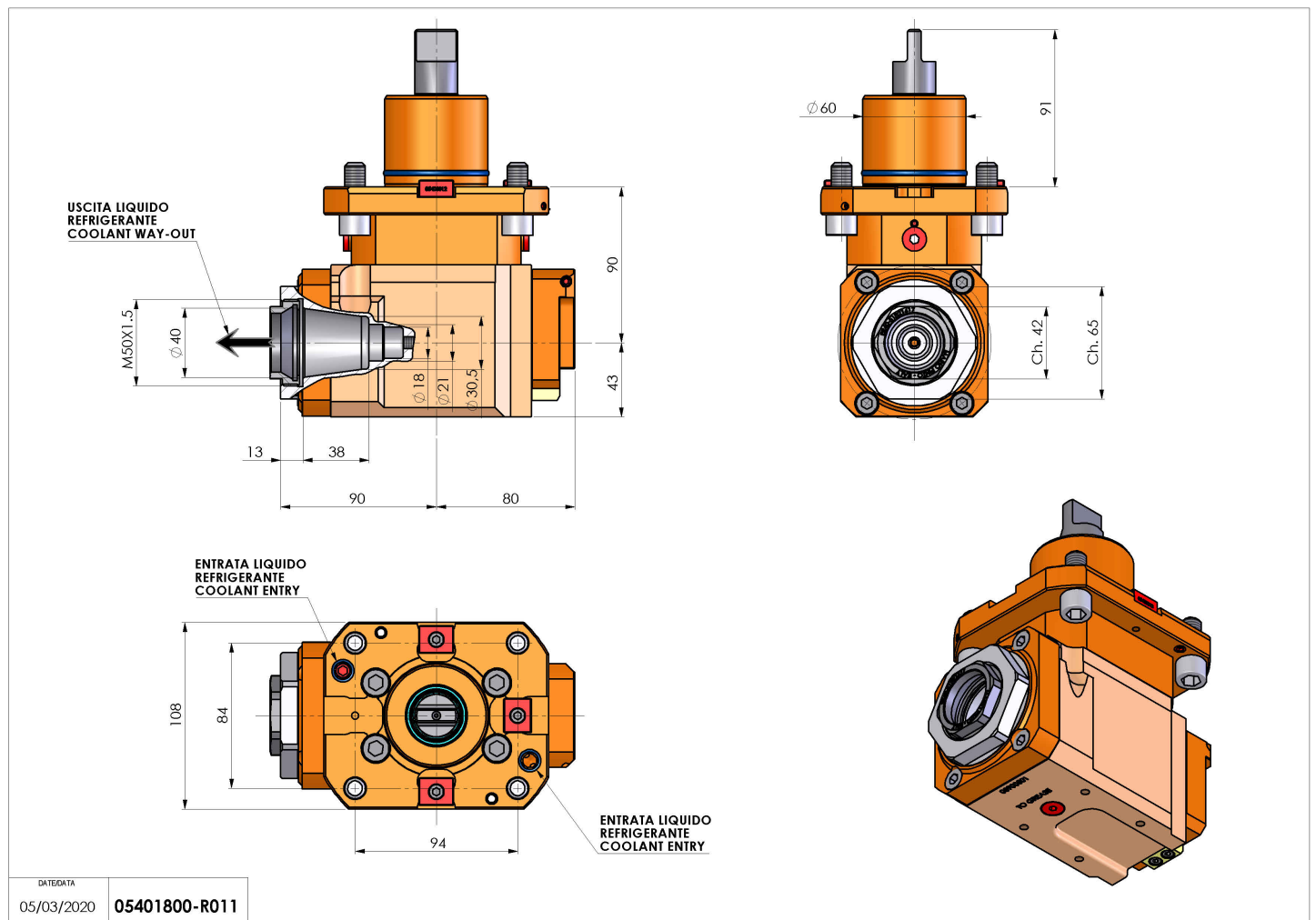

DATE/DATE: 05/03/2020
05401800-R011

Subject to technical changes