

05401100 - LT-S D60 WELDON-20 RF H119

Type	LT-S Tool holder straight
Mounting	CYLINDRICAL SHANK 60
Tool output	Weldon 20 DIN1835B
Coolant	Internal coolant
Direction of rotation	r1 ↻ r2 ↻
Max speed [rpm]	6000
Max torque [Nm]	70
Ratio	1:1
H [mm]	108
Accessories	N.A.
Notes	N.A.
Mounting tips	Not suitable for every application, please check

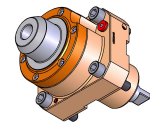

Always check live tool dimensions on the turret

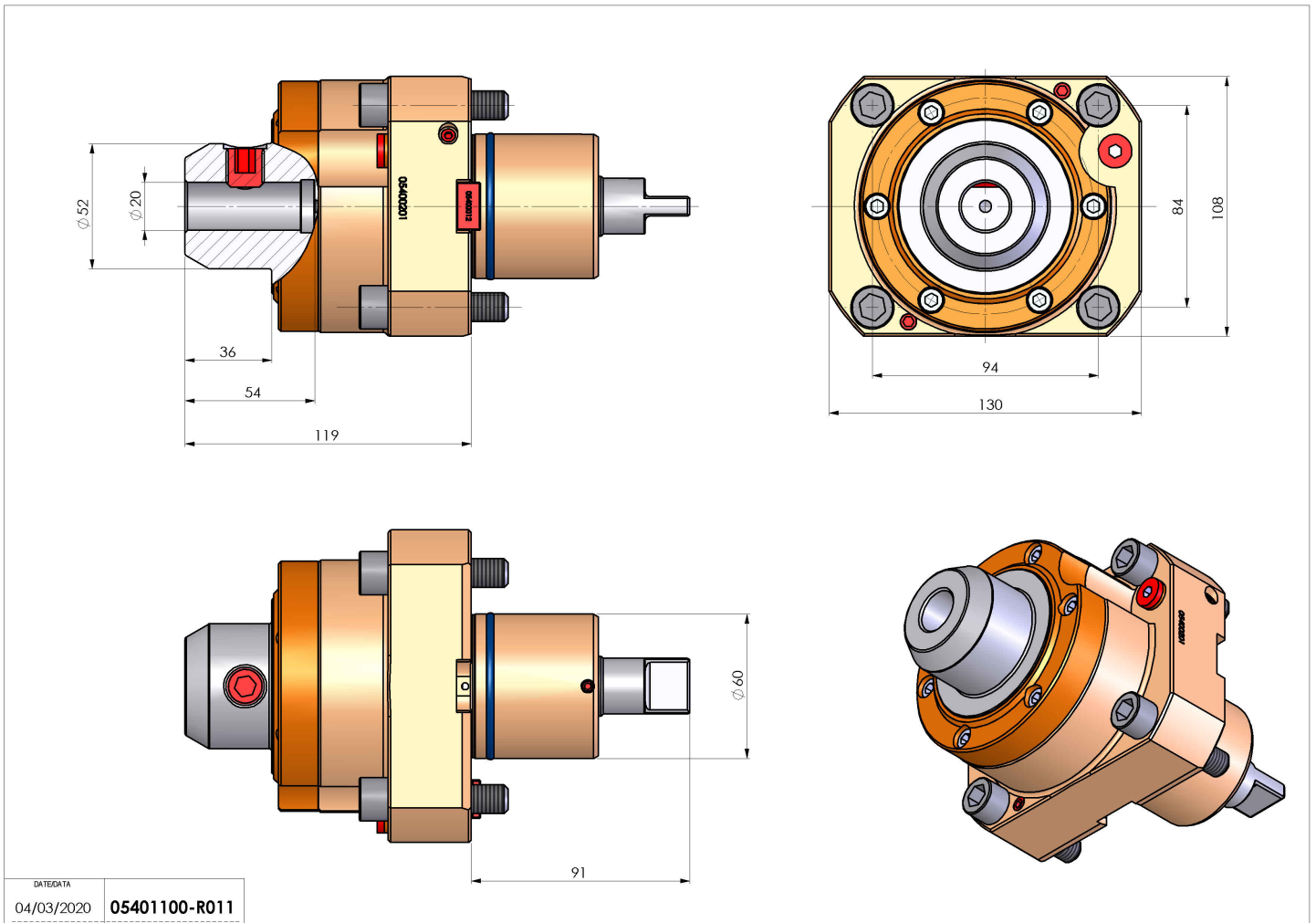

DATE/DATA
04/03/2020 05401100-R011

Subject to technical changes