



## 05400400 - LT-S D60 ER32F HRF H95

<b>Type</b>	LT-S Tool holder straight
<b>Mounting</b>	CYLINDRICAL SHANK 60
<b>Tool output</b>	Collet nut ER 32 F - internal nut
<b>Coolant</b>	HP Internal coolant
<b>Direction of rotation</b>	r1  r2 
<b>Max speed [rpm]</b>	6000
<b>Max torque [Nm]</b>	70
<b>Ratio</b>	1:1
<b>H [mm]</b>	95
<b>Max pressure [bar]</b>	70
<b>Accessories</b>	N.A.
<b>Notes</b>	N.A.
<b>Mounting tips</b>	Not suitable for every application, please check



Always check live tool dimensions on the turret

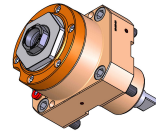
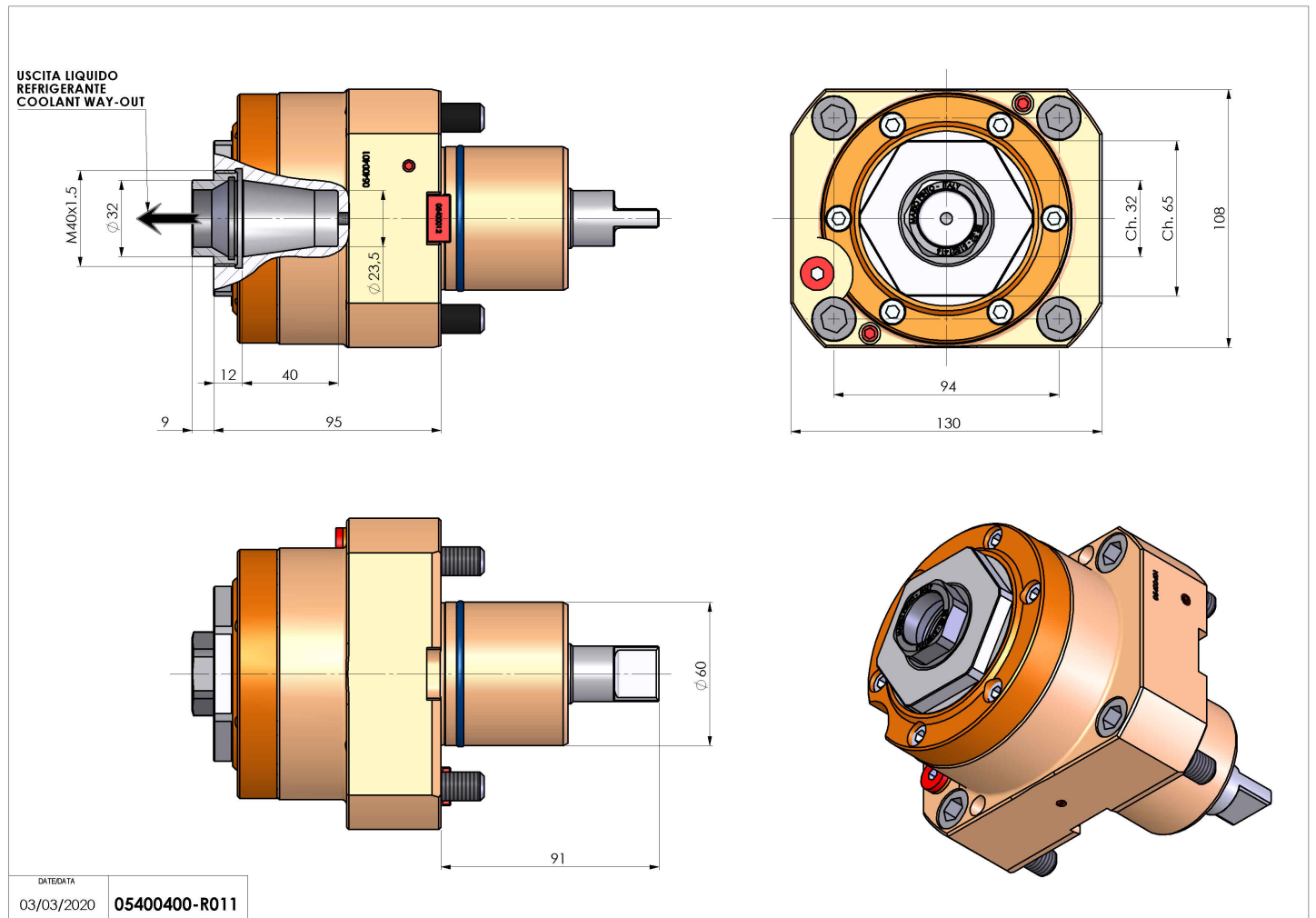

Subject to technical changes