

05385300 - LT-S D65 ER25F RF H69

Type	LT-S Tool holder straight
Mounting	CYLINDRICAL SHANK 65
Tool output	Collet nut ER 25 F - internal nut
Coolant	Internal coolant
Direction of rotation	r1 r2
Max speed [rpm]	6000
Max torque [Nm]	70
Ratio	1:1
H [mm]	69
Accessories	N.A.
Notes	N.A.
Mounting tips	Not suitable for every application, please check

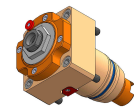

Always check live tool dimensions on the turret

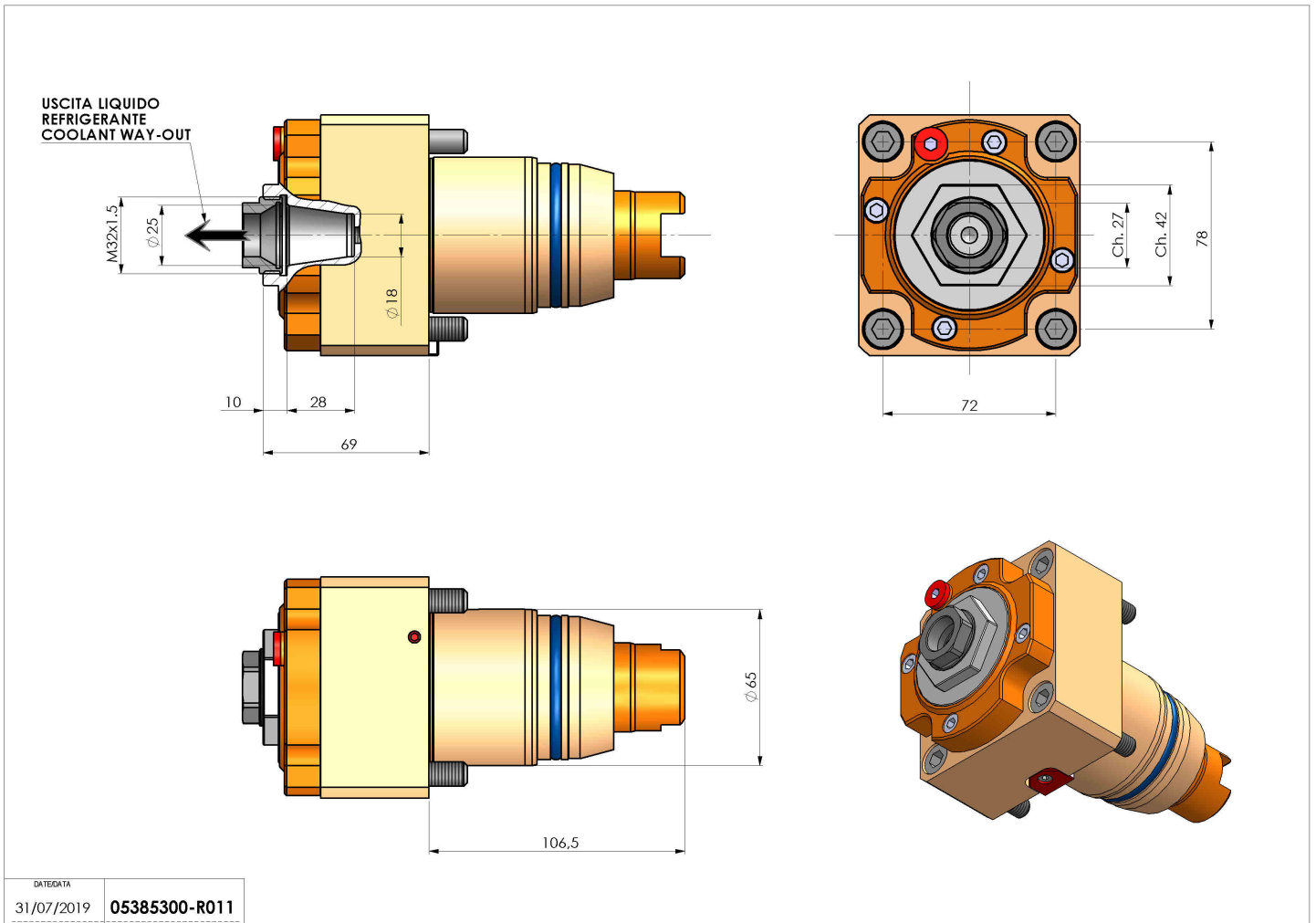

DATE/DATE	31/07/2019	05385300-R011
-----------	------------	---------------

Subject to technical changes