

05358900 - LT-S D68 ER32 RF H88

Type	LT-S Tool holder straight
Mounting	CYLINDRICAL SHANK 68
Tool output	Collet nut ER 32
Coolant	Internal coolant
Direction of rotation	r1 ↻ r2 ↻
Max speed [rpm]	6000
Max torque [Nm]	63
Ratio	1:1
H [mm]	88
Accessories	N.A.
Notes	N.A.
Mounting tips	Not suitable for every application, please check

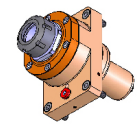

Always check live tool dimensions on the turret

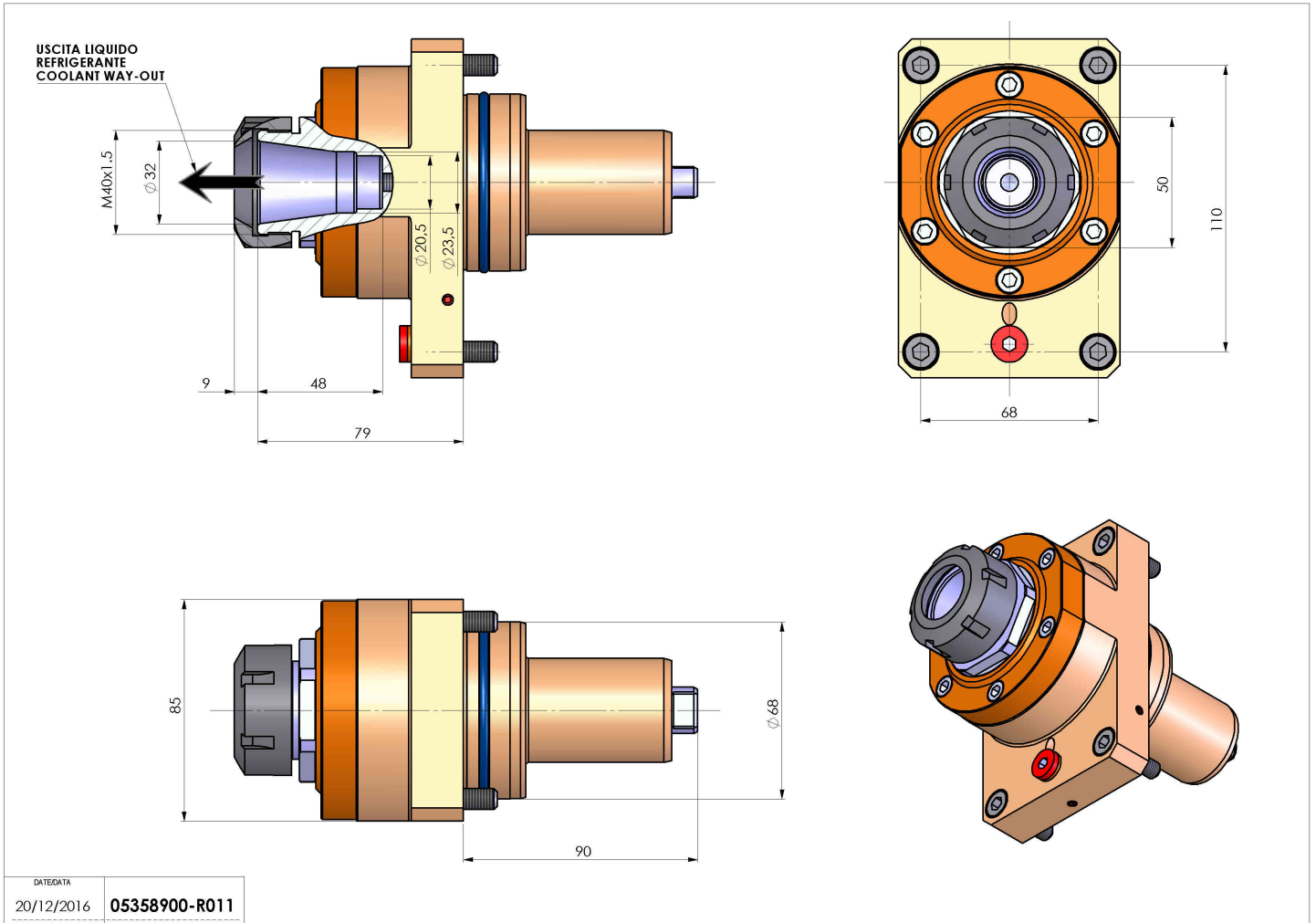

DATE/DATE	05358900-R011
20/12/2016	

Subject to technical changes