

05338200 - LT-A BMT45 ER25F LR H65

Type	LT-A Tool holder angle 90°
Mounting	BMT 45
Tool output	Collet nut ER 25 F - internal nut
Coolant	External coolant
Direction of rotation	r1 ↻ r2 ↻
Max speed [rpm]	6000
Max torque [Nm]	25
Ratio	1:1
H [mm]	65
H1 [mm]	32.5
Accessories	N.A.
Notes	N.A.
Mounting tips	Not suitable for every application, please check

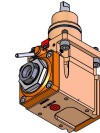

Always check live tool dimensions on the turret

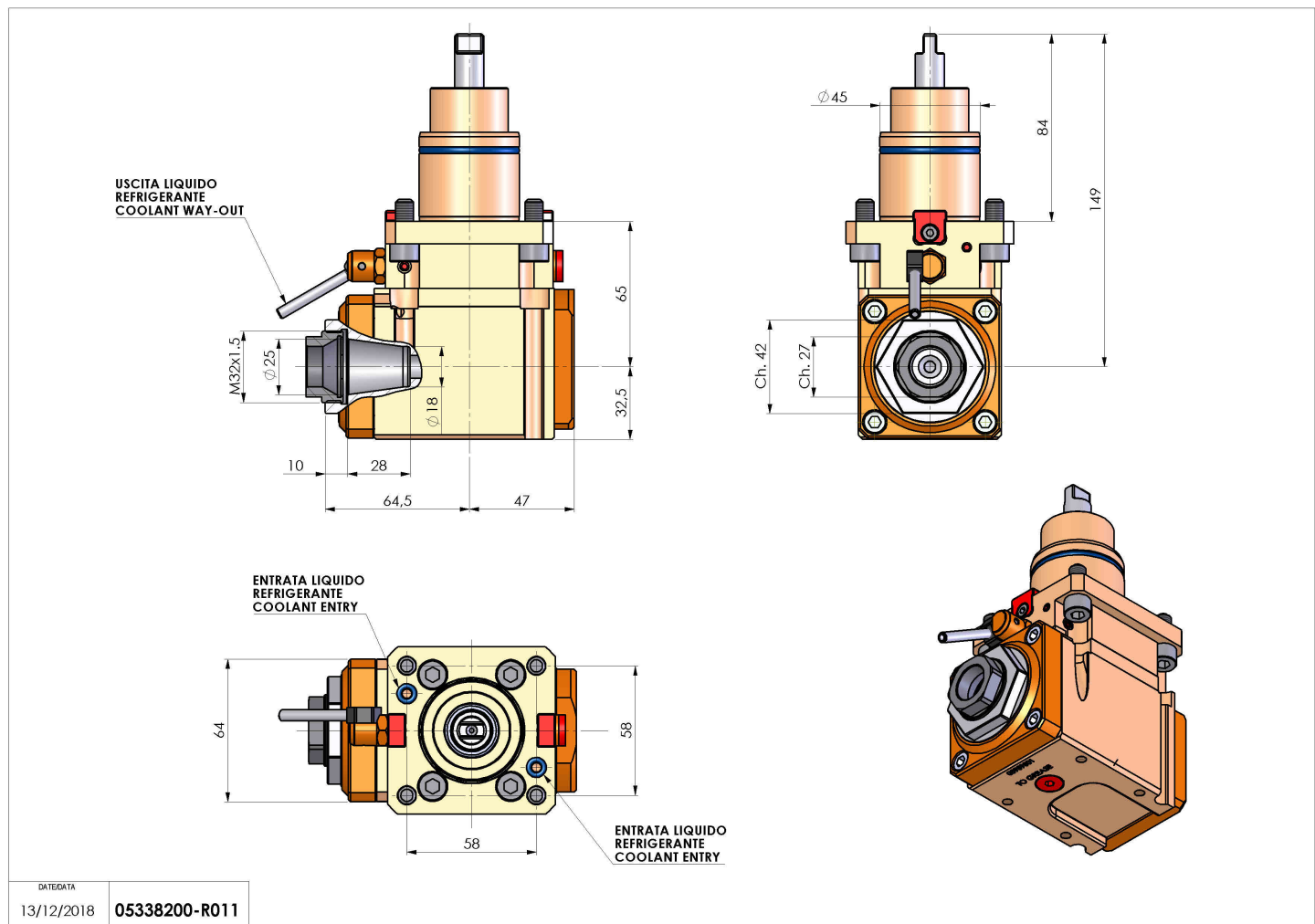

Subject to technical changes