

05333500 - LT-S BMT55 ER32F HRF H75

Type	LT-S Tool holder straight
Mounting	BMT 55
Tool output	Collet nut ER 32 F - internal nut
Coolant	HP Internal coolant
Direction of rotation	r1 r2
Max speed [rpm]	6000
Max torque [Nm]	40
Ratio	1:1
H [mm]	75
Max pressure [bar]	70
Accessories	N.A.
Notes	N.A.
Mounting tips	Not suitable for every application, please check

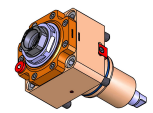

Always check live tool dimensions on the turret

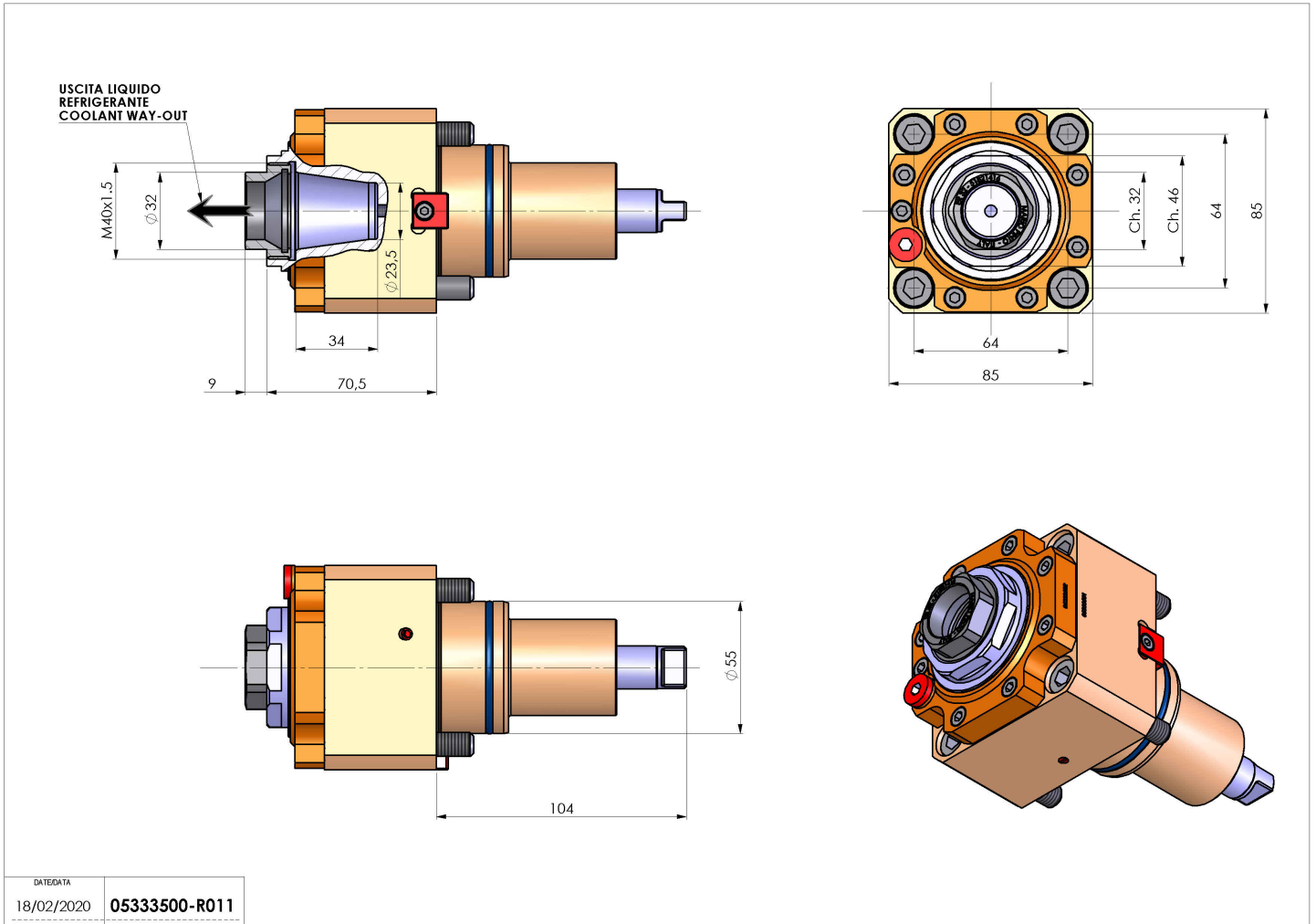

DATE/DATE	18/02/2020
PART NUMBER	05333500-R011

Subject to technical changes