

05319800 - LT-A BMT55 BD ER32F RF H70

Type	LT-A Tool holder angle 90°
Mounting	BMT 55 BIG DRIVE
Tool output	Collet nut ER 32 F - internal nut
Coolant	Internal coolant
Direction of rotation	r1 r2
Max speed [rpm]	6000
Max torque [Nm]	40
Ratio	1:1
H [mm]	70
H1 [mm]	32.5
Accessories	N.A.
Notes	N.A.
Mounting tips	Not suitable for every application, please check

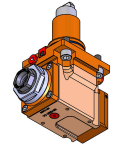

Always check live tool dimensions on the turret

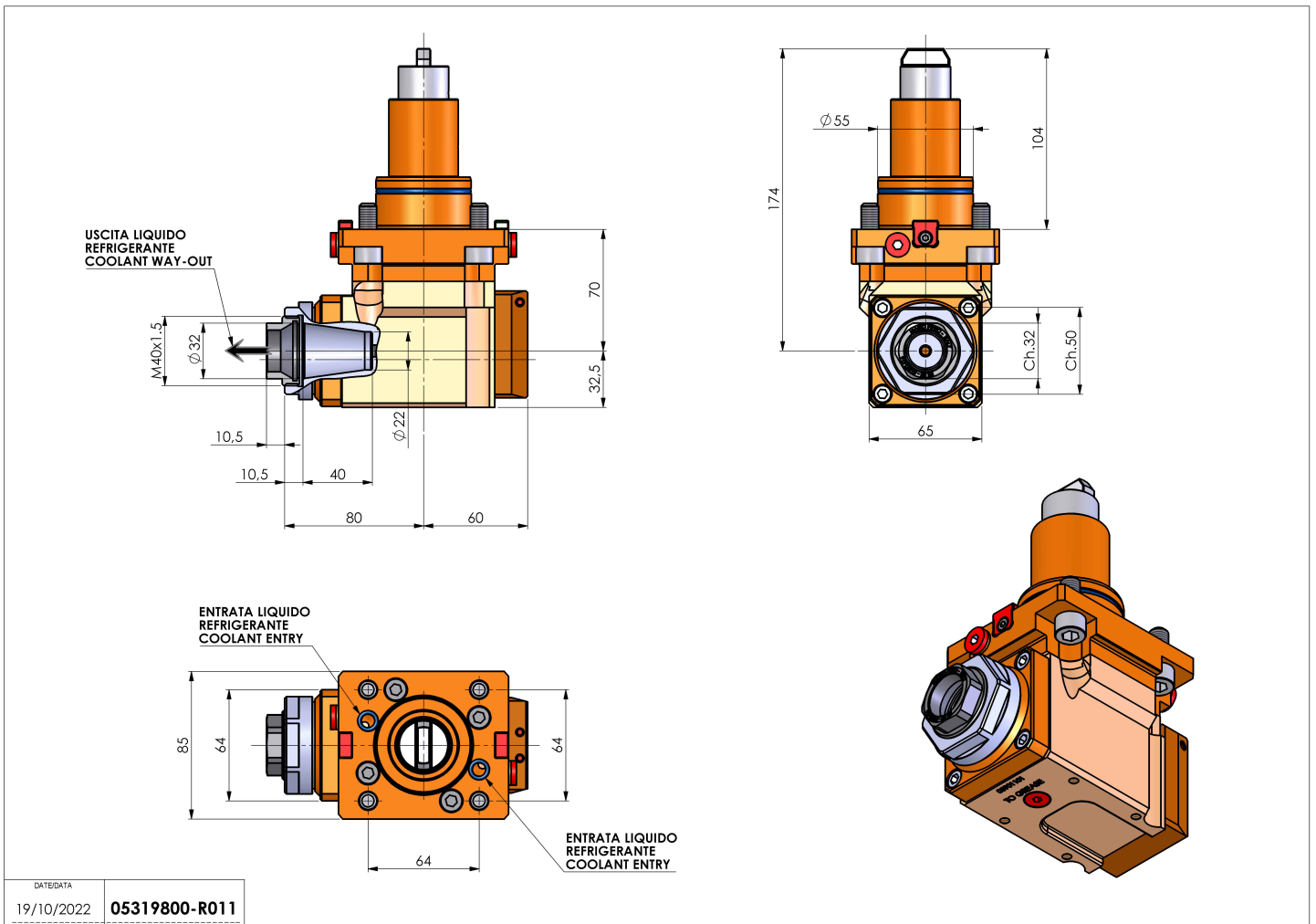

DATE/DATE	05319800-R011
19/10/2022	

Subject to technical changes