



05313400 - LT-A BMT65 BD ER32F LR HRF H72

Type	LT-A Tool holder angle 90°
Mounting	BMT 65 BIG DRIVE
Tool output	Collet nut ER 32 F - internal nut
Coolant	HP Internal coolant
Direction of rotation	r1  r2 
Max speed [rpm]	6000
Max torque [Nm]	63
Ratio	1:1
H [mm]	72
H1 [mm]	38
Max pressure [bar]	80
Accessories	N.A.
Notes	N.A.
Mounting tips	Not suitable for every application, please check



Always check live tool dimensions on the turret

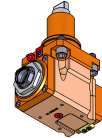
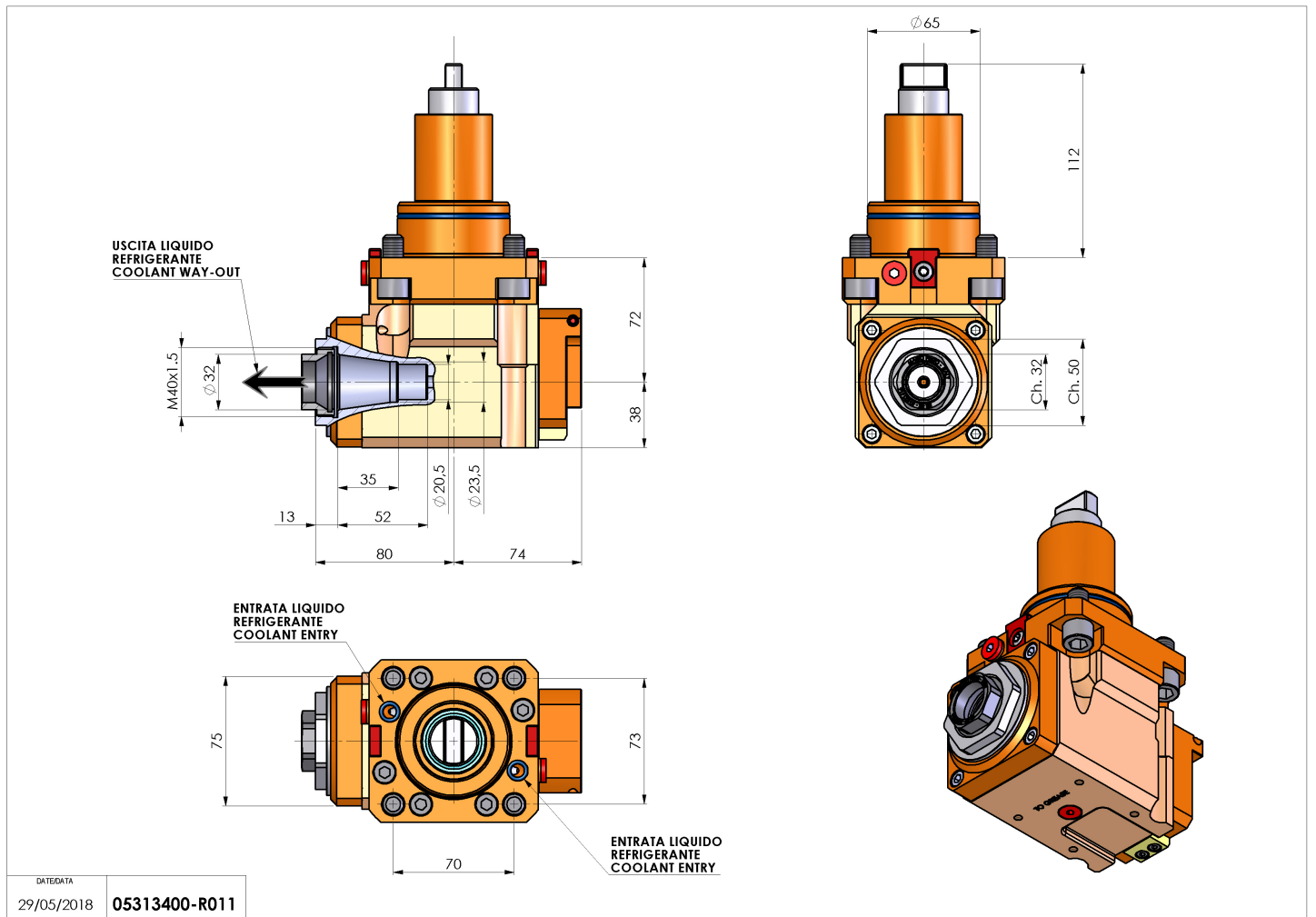

Subject to technical changes