



05311900 - LT-S BMT55 BD ER25 H80

Type	LT-S Tool holder straight
Mounting	BMT 55 BIG DRIVE
Tool output	Collet nut ER 25
Coolant	External coolant
Direction of rotation	r1  r2 
Max speed [rpm]	6000
Max torque [Nm]	60
Ratio	1:1
H [mm]	80
Accessories	N.A.
Notes	N.A.
Mounting tips	Not suitable for every application, please check



Always check live tool dimensions on the turret

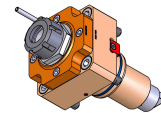
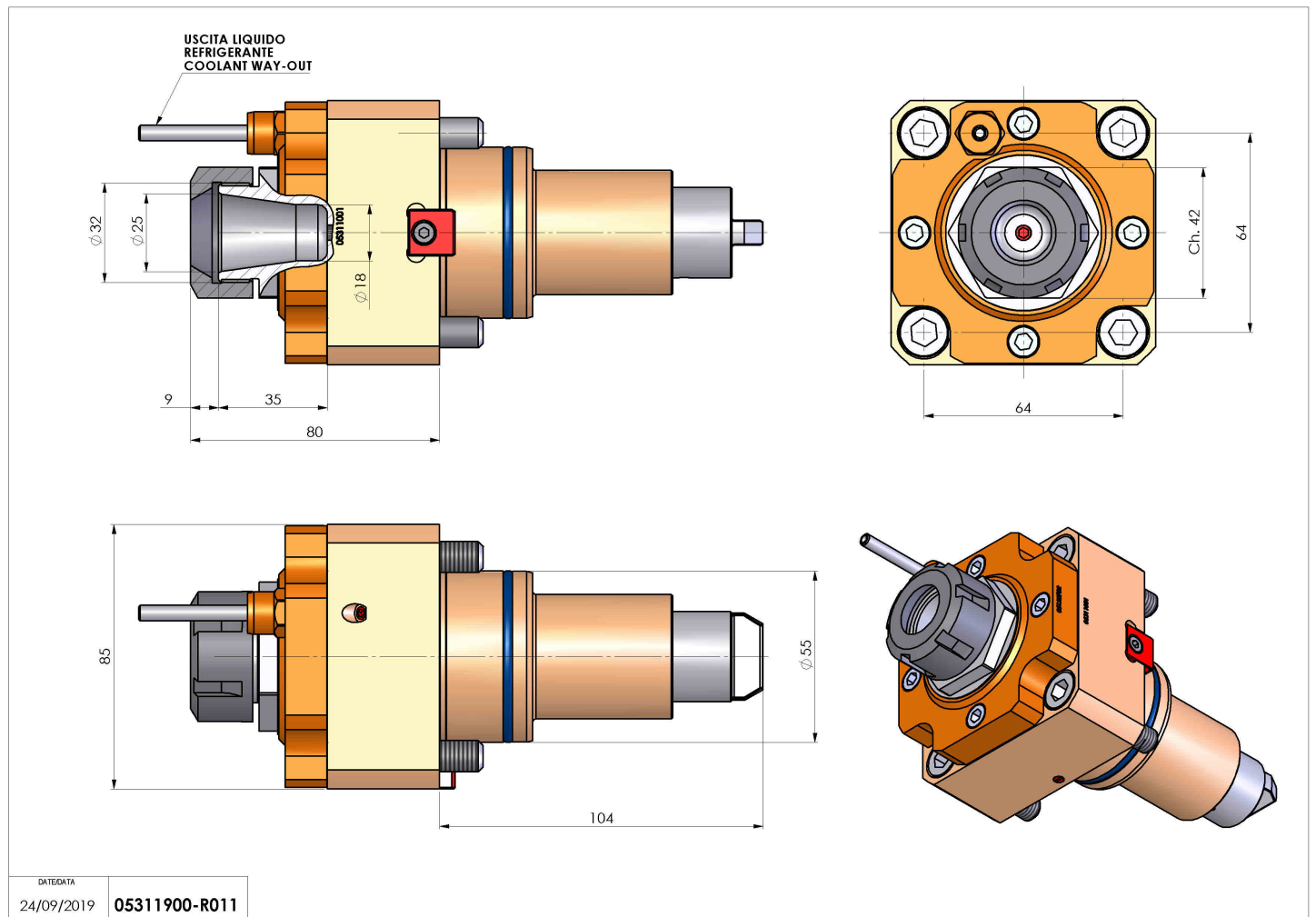

DATE/DATE
24/09/2019 05311900-R011

Subject to technical changes