



05311400 - LT-S BMT55 BD ER32F RF H65

Type	LT-S Tool holder straight
Mounting	BMT 55 BIG DRIVE
Tool output	Collet nut ER 32 F - internal nut
Coolant	Internal coolant
Direction of rotation	r1  r2 
Max speed [rpm]	6000
Max torque [Nm]	60
Ratio	1:1
H [mm]	65
Accessories	N.A.
Notes	N.A.
Mounting tips	Not suitable for every application, please check



Always check live tool dimensions on the turret

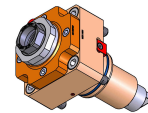
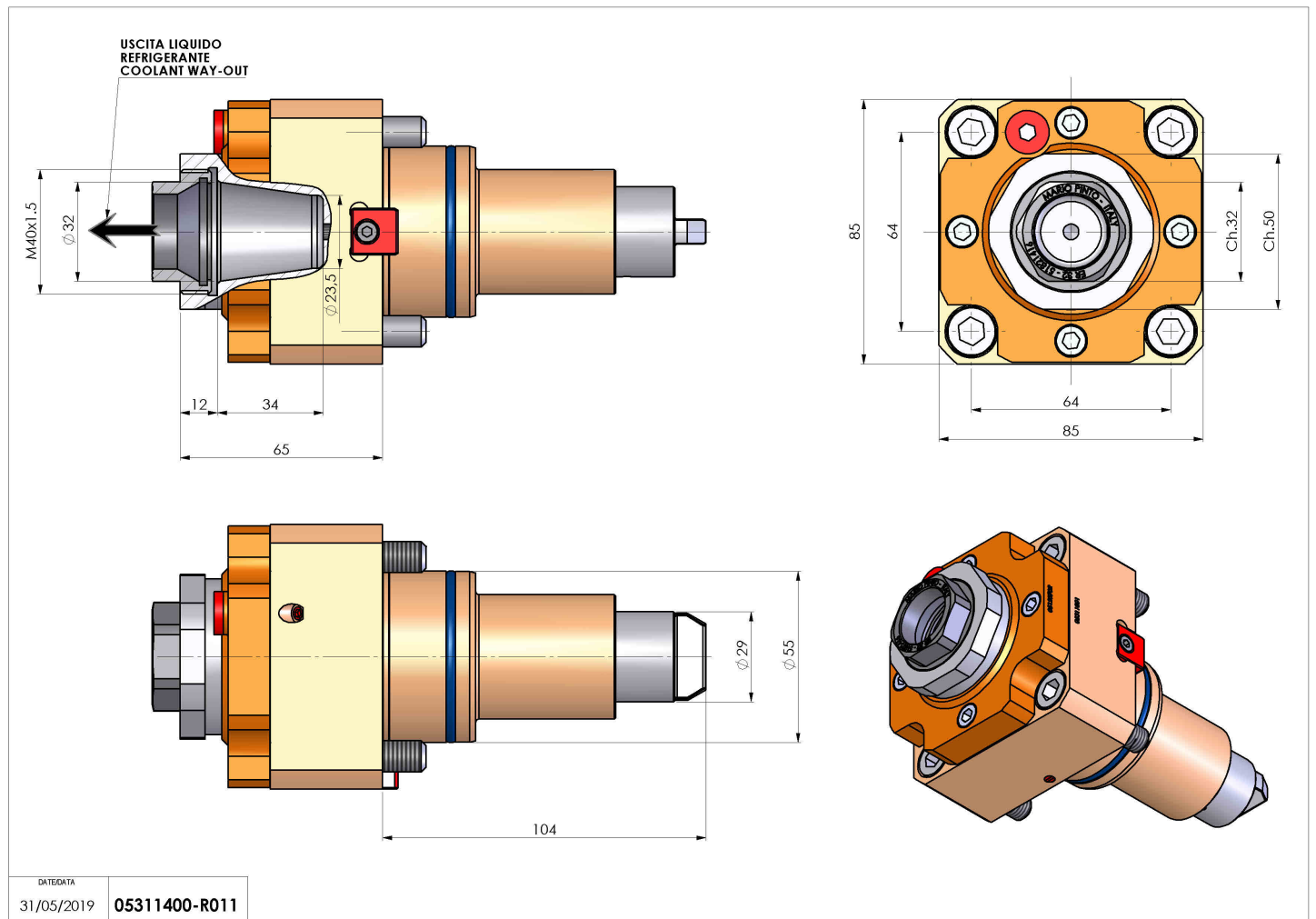

Subject to technical changes