

05309500 - LT-A BMT65 ER32 LR H100

Type	LT-A Tool holder angle 90°
Mounting	BMT 65
Tool output	Collet nut ER 32
Coolant	External coolant
Direction of rotation	r1 ↻ r2 ↻
Max speed [rpm]	6000
Max torque [Nm]	63
Ratio	1:1
H [mm]	100
H1 [mm]	38
Accessories	N.A.
Notes	N.A.
Mounting tips	Not suitable for every application, please check

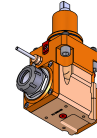

Always check live tool dimensions on the turret

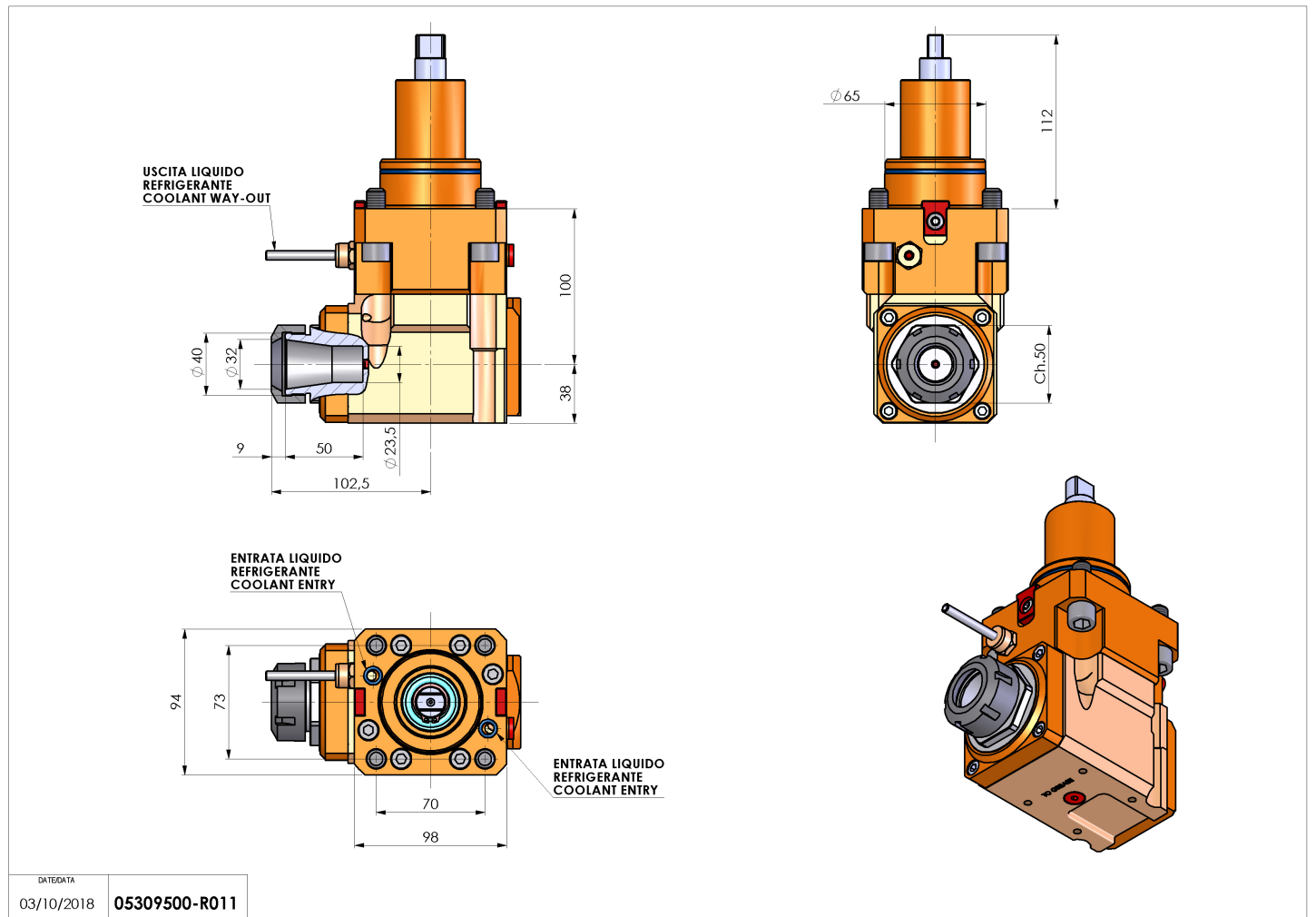

DATE/DATE
03/10/2018 05309500-R011

Subject to technical changes