

05306400 - LT-S BMT85 HSK63 OFS125 RFH100

Type	LT-S OFS Tool holder straight offset
Mounting	BMT 85
Tool output	Quick Change HSK63
Coolant	Internal coolant
Offset [mm]	125
Direction of rotation	r1 ↻ r2 ↻
Max speed [rpm]	4000
Max torque [Nm]	180
Ratio	1:1
H [mm]	100
Accessories	N.A.
Notes	N.A.
Mounting tips	Not suitable for every application, please check

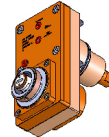

Always check live tool dimensions on the turret

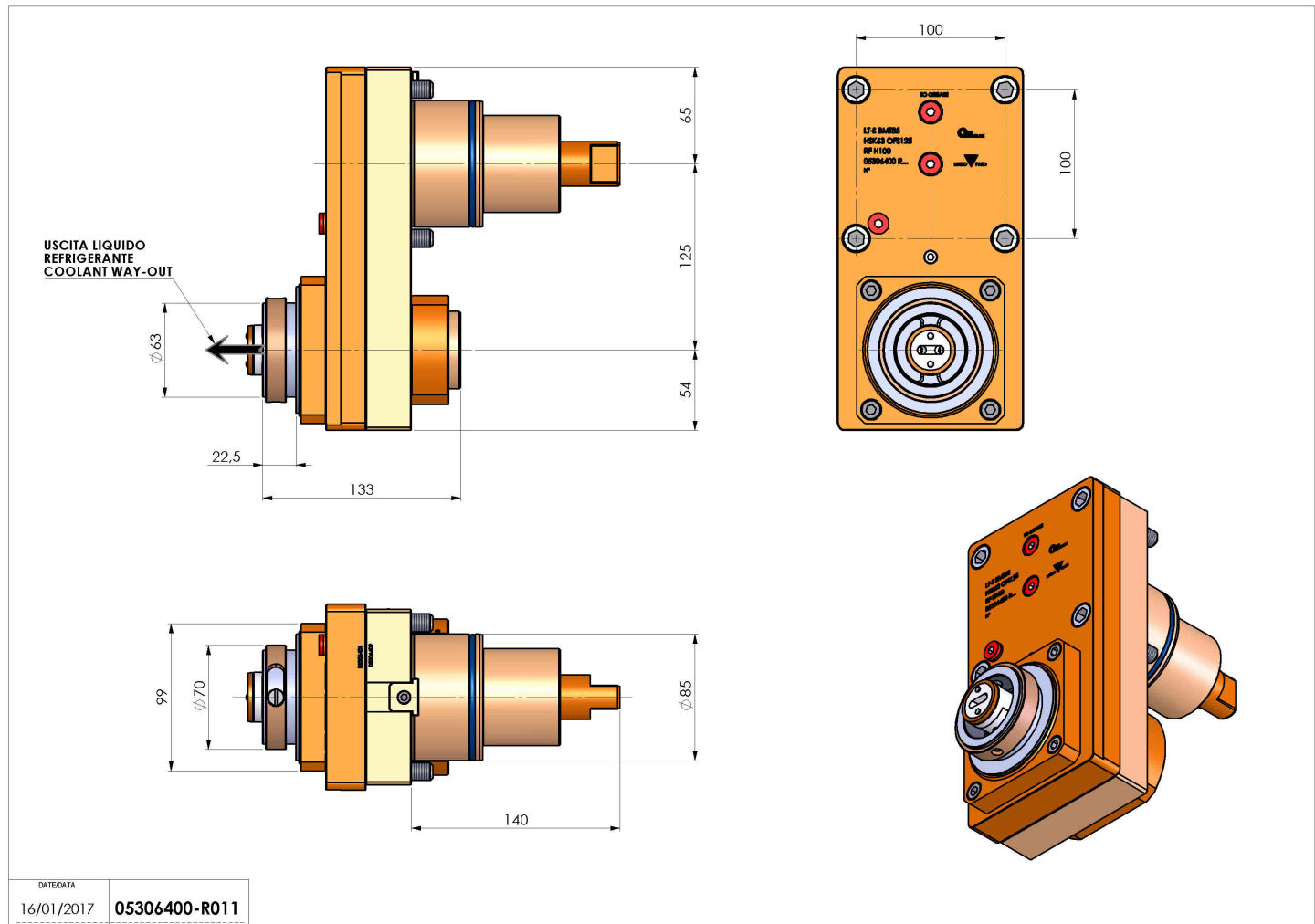

Subject to technical changes