

05305300 - LT-A ST-65 BMT75 C16 H110

Type	LT-A ST Slotting tool 90°
Mounting	BMT 75
Tool output	Tool diameter 16
Coolant	External coolant
Max speed [rpm]	500
Max torque [Nm]	17,5
Ratio	1:1
Y axis adjustment	NO
Feed pushing [N]	1000
Stroke [mm]	65
Work stroke [mm]	60
H [mm]	110
Accessories	N.A.
Notes	N.A.
Mounting tips	Not suitable for every application, please check

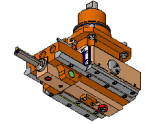

Always check live tool dimensions on the turret

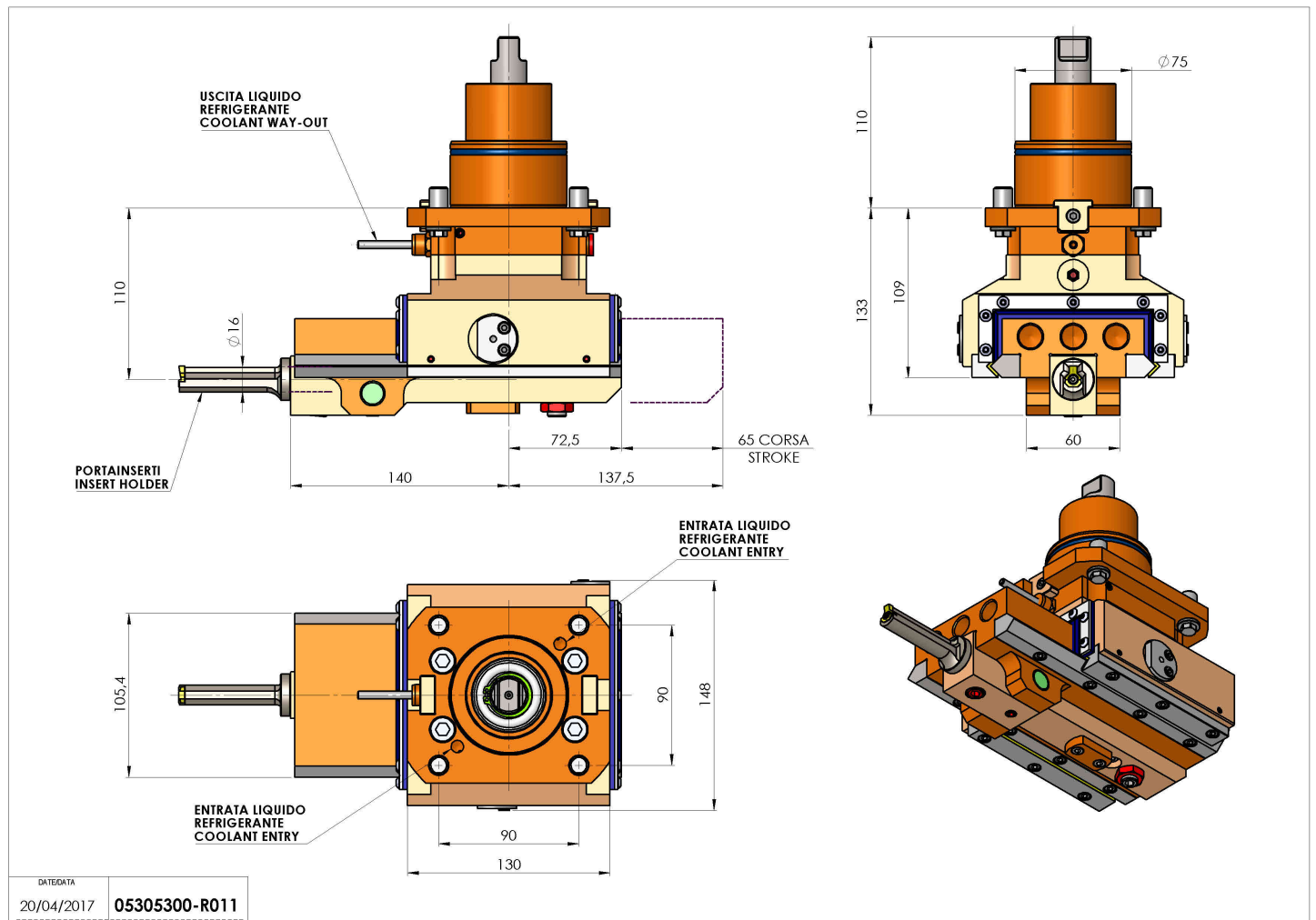

DATE/DATE: 20/04/2017
05305300-R011

Subject to technical changes