



05293100 - LT-S D32 C4 HRF H37

Type	LT-S Tool holder straight
Mounting	CYLINDRICAL SHANK 32
Tool output	Polygonal shank C40 ISO 26623-1
Coolant	HP Internal coolant
Direction of rotation	r1  r2 
Max speed [rpm]	10000
Max torque [Nm]	70
Ratio	1:1
H [mm]	37
Max pressure [bar]	70
Accessories	N.A.
Notes	N.A.
Mounting tips	Not suitable for every application, please check



Always check live tool dimensions on the turret

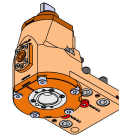
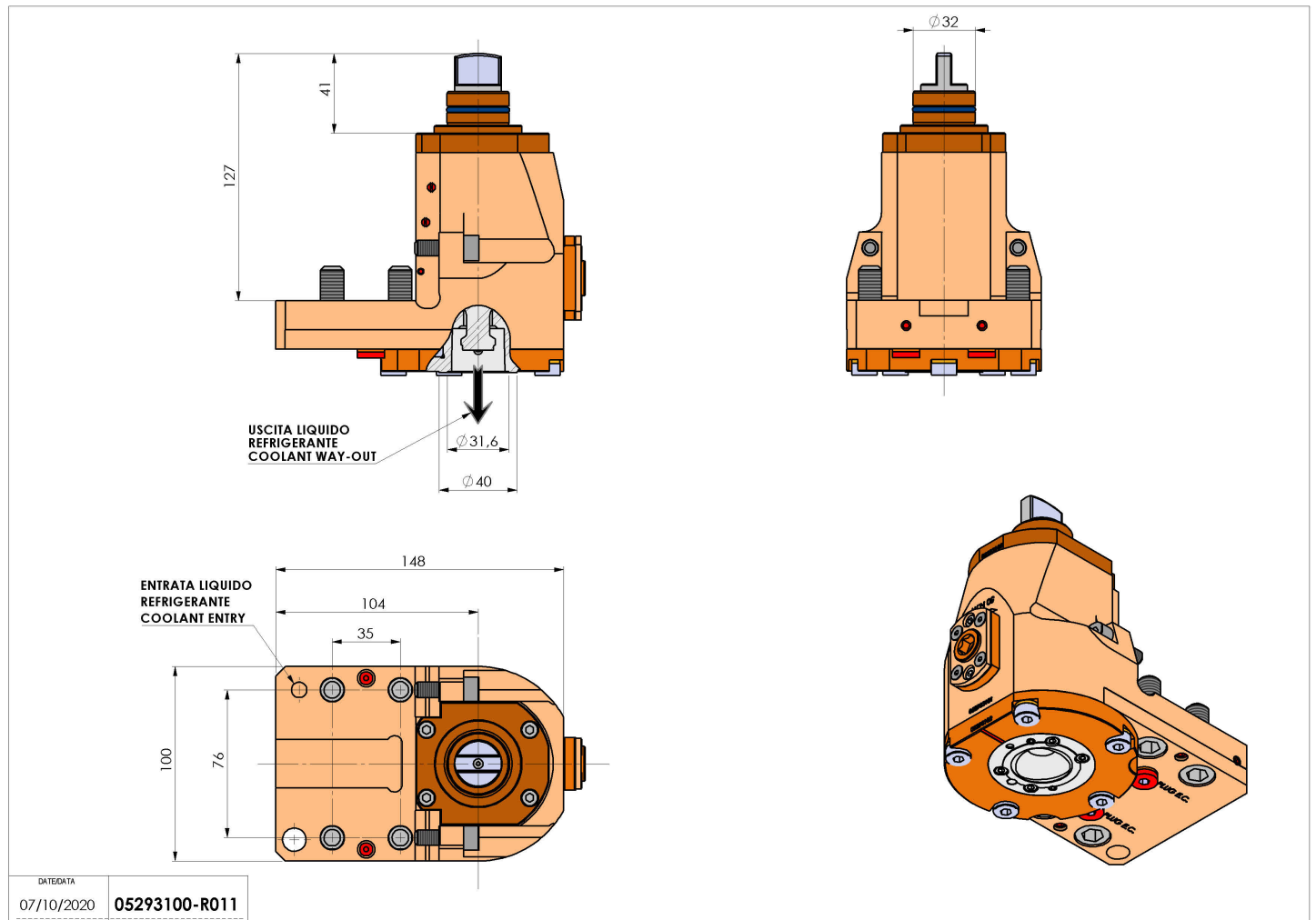

Subject to technical changes