



05264200 - LT-A D60 HSK40 HRF H85

Type	LT-A Tool holder angle 90°
Mounting	CYLINDRICAL SHANK 60
Tool output	Quick Change HSK40
Coolant	HP Internal coolant
Direction of rotation	r1  r2 
Max speed [rpm]	6000
Max torque [Nm]	100
Ratio	1:1
H [mm]	85
H1 [mm]	43
Max pressure [bar]	80
Accessories	N.A.
Notes	N.A.
Mounting tips	Not suitable for every application, please check



Always check live tool dimensions on the turret

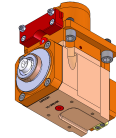
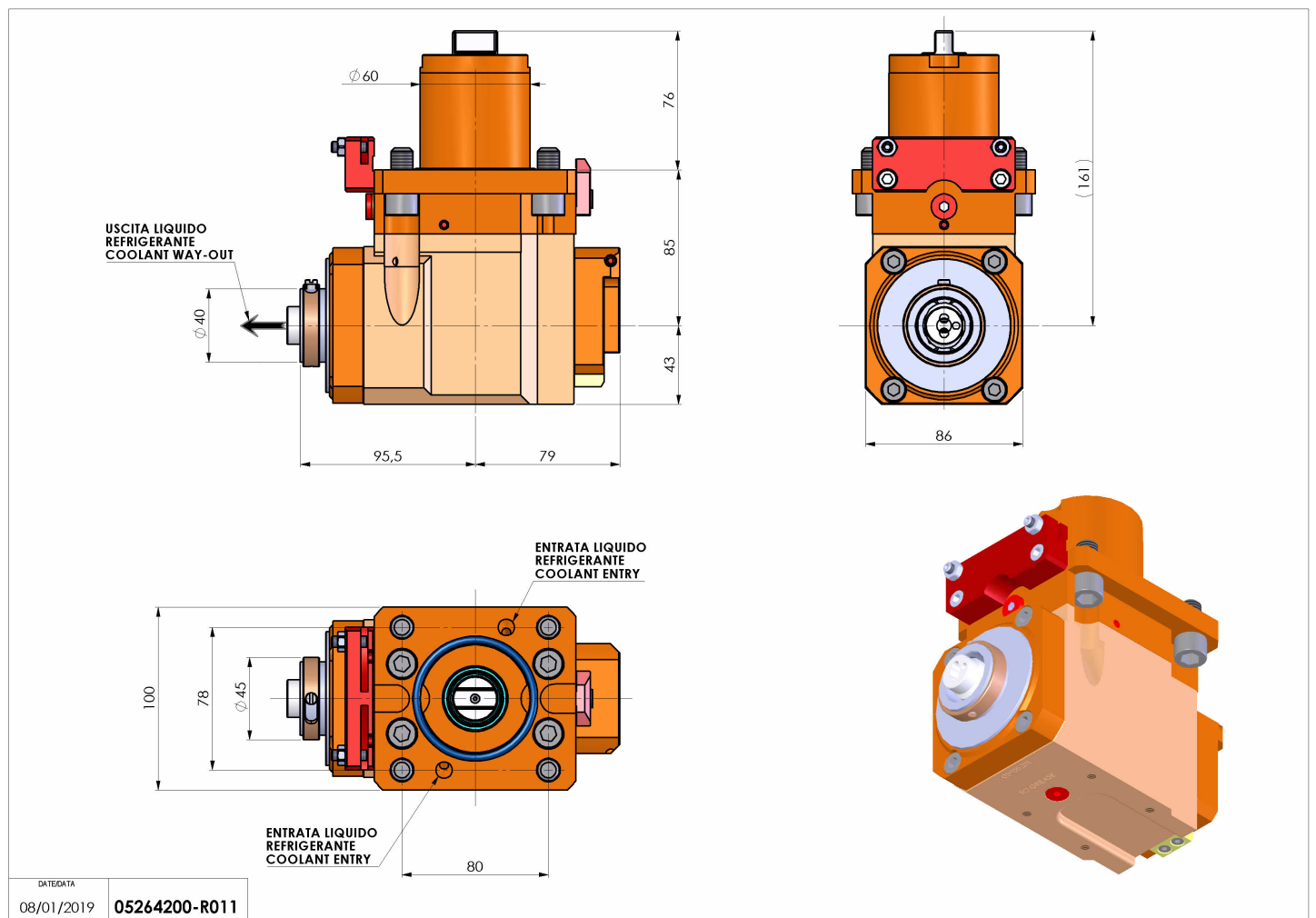

Subject to technical changes