



05262000 - LT-A D60 ER32F L-R HRF H90

Type	LT-A Tool holder angle 90°
Mounting	CYLINDRICAL SHANK 60
Tool output	Collet nut ER 32 F - internal nut
Coolant	HP Internal coolant
Direction of rotation	r1  r2 
Max speed [rpm]	6000
Max torque [Nm]	63
Ratio	1:1
H [mm]	90
H1 [mm]	38
Max pressure [bar]	80
Accessories	N.A.
Notes	N.A.
Mounting tips	Not suitable for every application, please check



Always check live tool dimensions on the turret

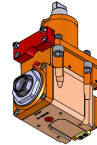
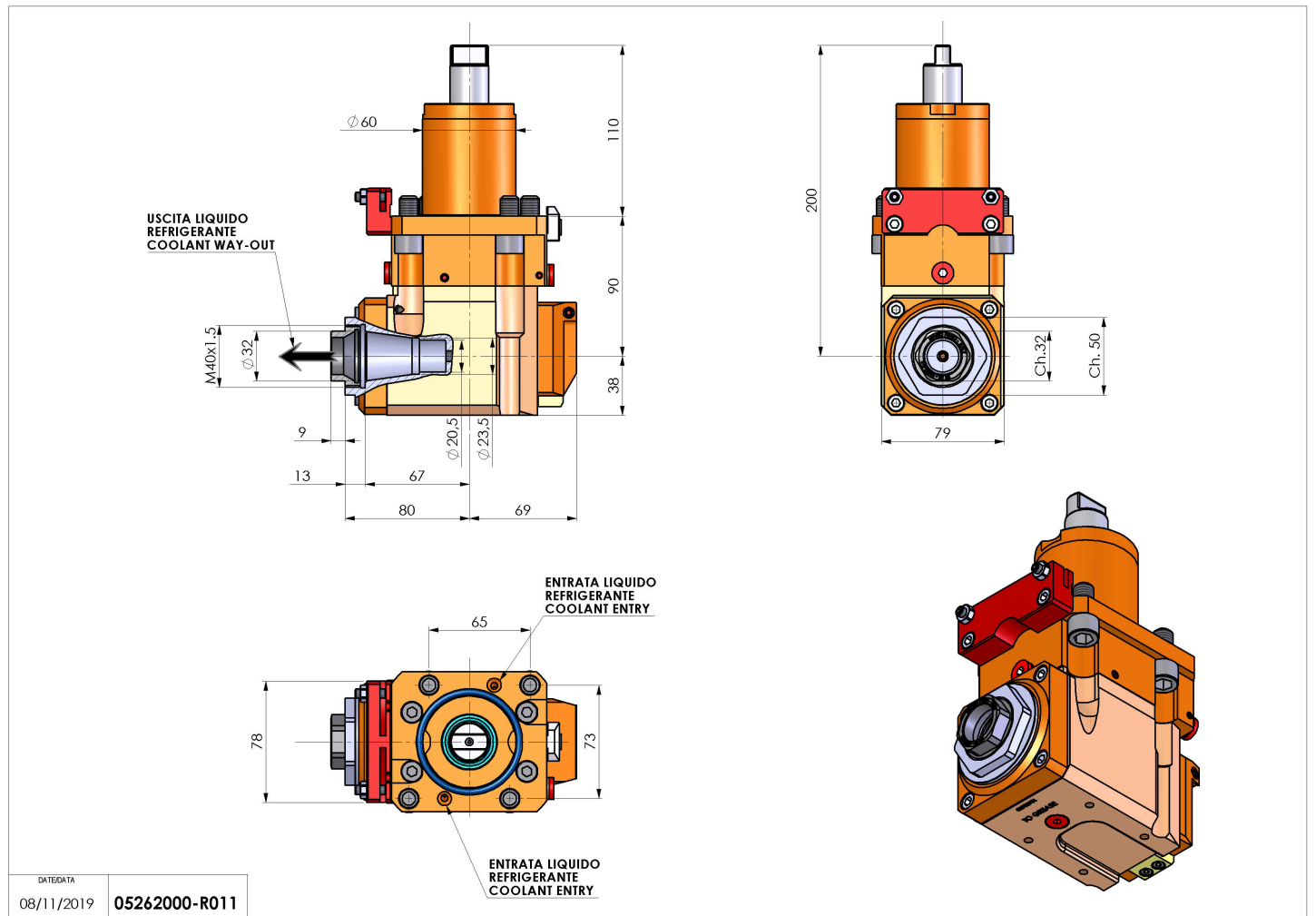

DATE/DATE
08/11/2019 05262000-R011

Subject to technical changes