

05256600 - LT-S VDI40 ER40F OFS76RFH108MZ

Type	LT-S OFS Tool holder straight offset
Mounting	VDI 40
Tool output	Collet nut ER 40 F - internal nut
Coolant	Internal coolant
Offset [mm]	76
Direction of rotation	r1 ↻ r2 ↻
Max speed [rpm]	4000
Max torque [Nm]	180
Ratio	1:1
H [mm]	108
Accessories	N.A.
Notes	N.A.



Mounting tips Not suitable for every application, please check

ATTENZIONE: VERIFICARE L'ORIENTAMENTO DELLA DENTATURA VDI

Always check live tool dimensions on the turret

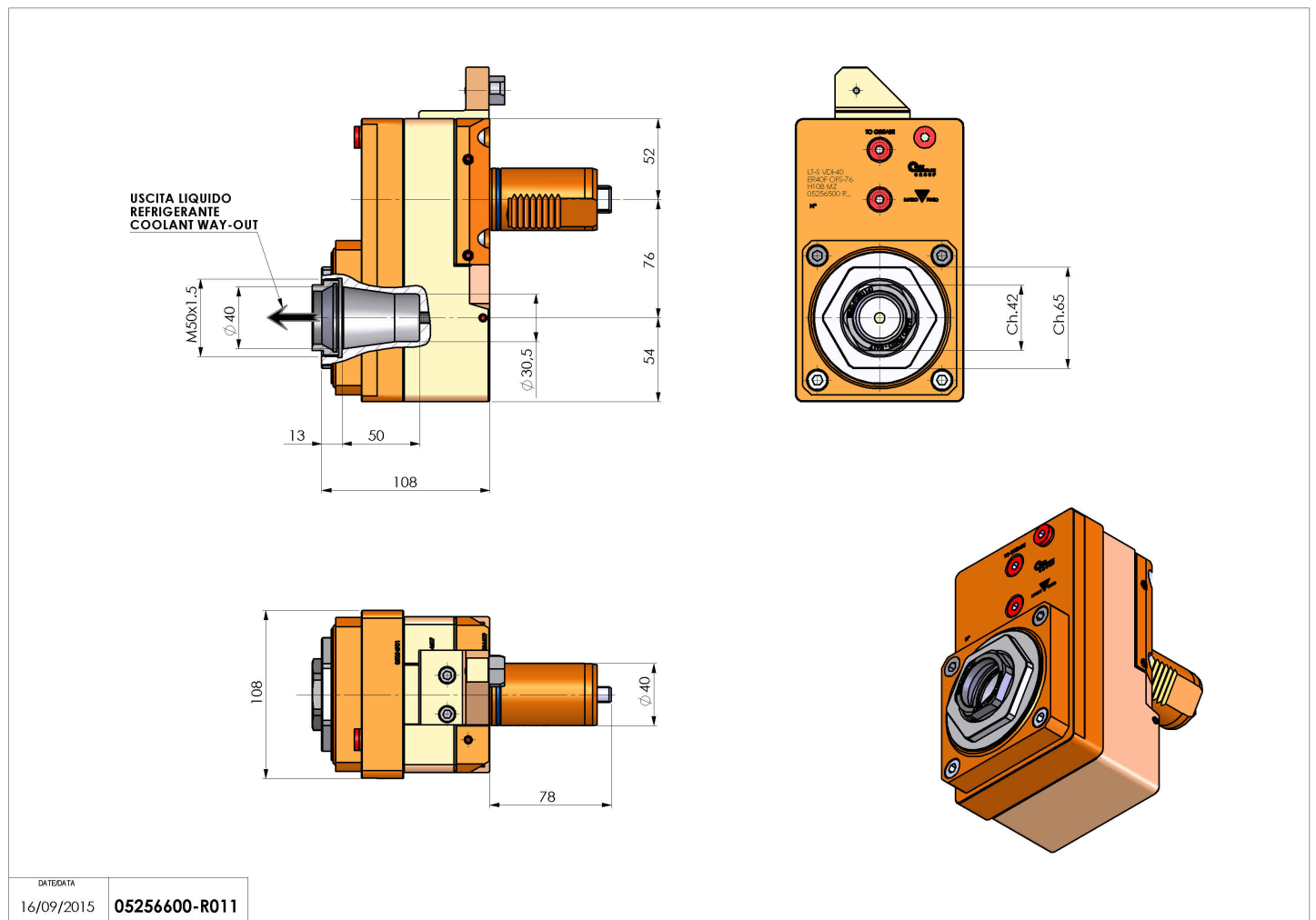

DATE/DATE	16/09/2015	05256600-R011
-----------	------------	---------------

Subject to technical changes