

05248100 - LT-A D40 ER32 HS H85

Type	LT-A Tool holder angle 90°
Mounting	CYLINDRICAL SHANK 40
Tool output	Collet nut ER 32
Coolant	External coolant
Direction of rotation	r1 r2
Max speed [rpm]	12000
Max torque [Nm]	50
Ratio	1:1
H [mm]	85
H1 [mm]	36
Accessories	N.A.
Notes	N.A.
Mounting tips	Not suitable for every application, please check

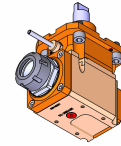

Always check live tool dimensions on the turret

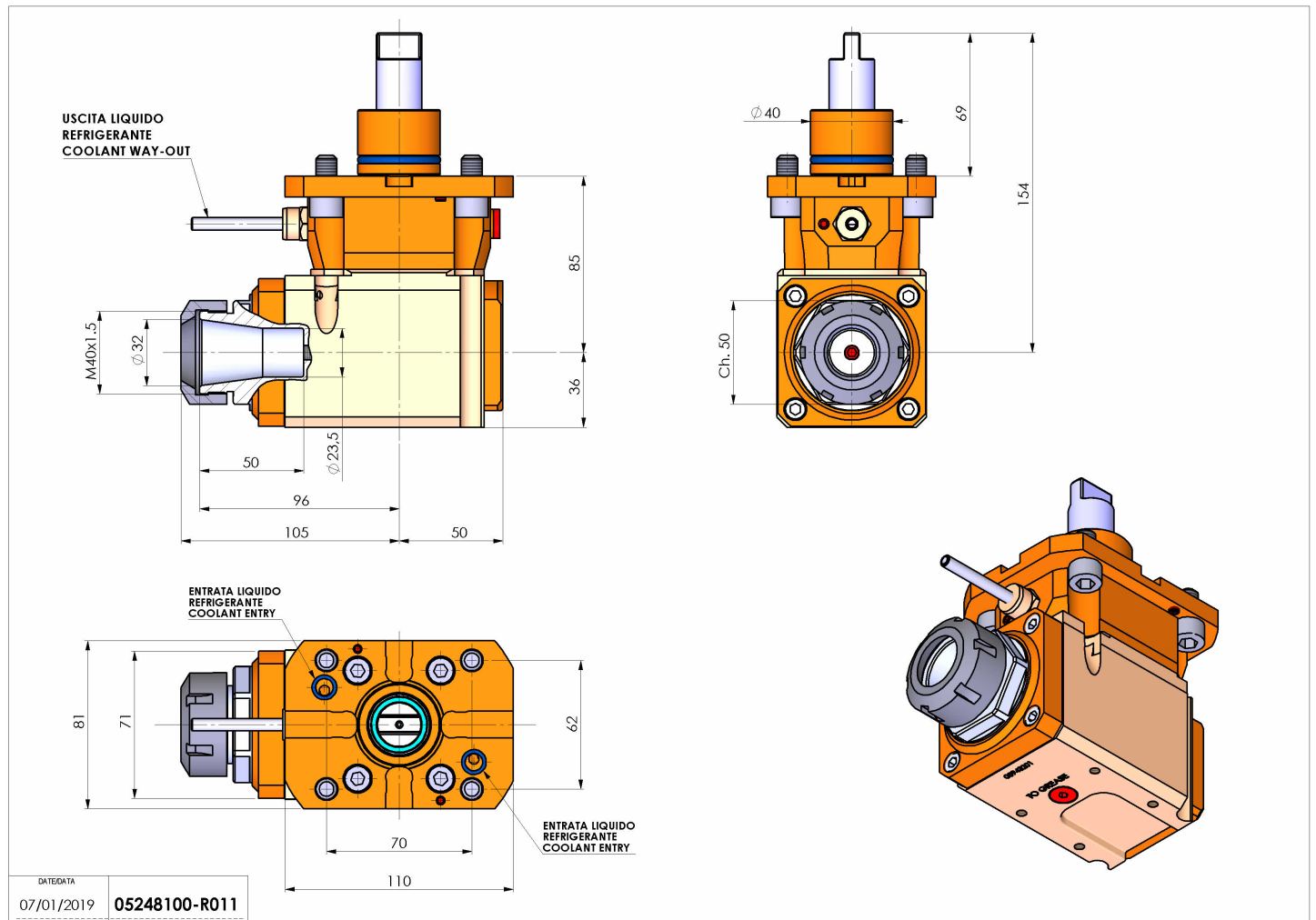

Subject to technical changes