

# 05246600 - LT-S D40 ER25F OFS90 HS H82

<b>Type</b>	LT-S OFS Tool holder straight offset
<b>Mounting</b>	CYLINDRICAL SHANK 40
<b>Tool output</b>	Collet nut ER 25 F - internal nut
<b>Coolant</b>	External coolant
<b>Offset [mm]</b>	90
<b>Direction of rotation</b>	r1 ↻ r2 ↻
<b>Max speed [rpm]</b>	12000
<b>Max torque [Nm]</b>	40
<b>Ratio</b>	1:1
<b>H [mm]</b>	81,5
<b>Accessories</b>	N.A.
<b>Notes</b>	N.A.
<b>Mounting tips</b>	Not suitable for every application, please check

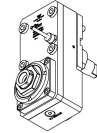

REPLACED BY 05248200

Always check live tool dimensions on the turret

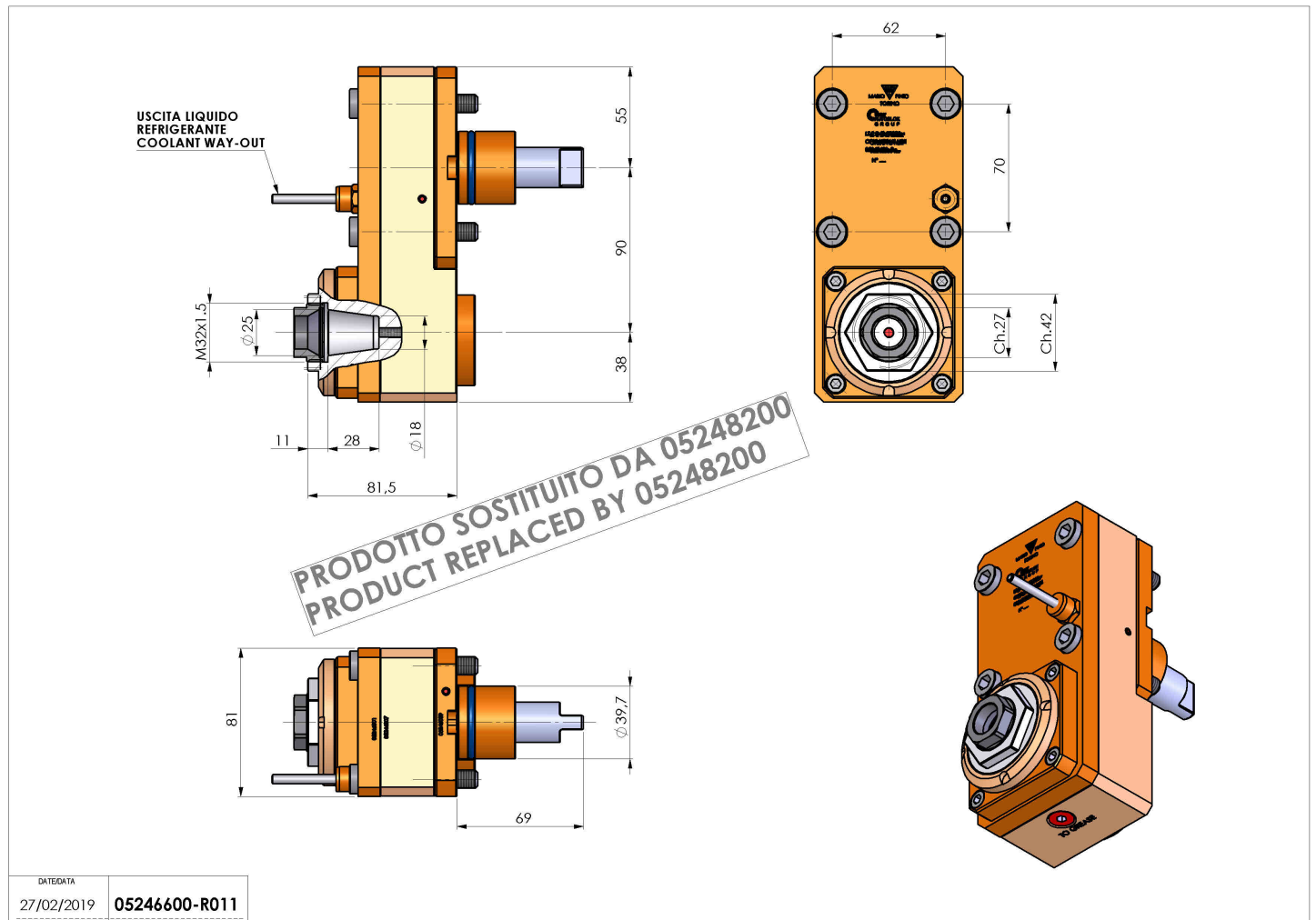

Subject to technical changes