

05244700 - LT-S D40 DIN138-16 HS H67

Type	LT-S Tool holder straight
Mounting	CYLINDRICAL SHANK 40
Tool output	Shell-Mill DIN138 16
Coolant	External coolant
Direction of rotation	r1 r2
Max speed [rpm]	12000
Max torque [Nm]	40
Ratio	1:1
H [mm]	67
Accessories	
Notes	N.A.
Mounting tips	Not suitable for every application, please check

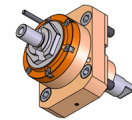

Always check live tool dimensions on the turret

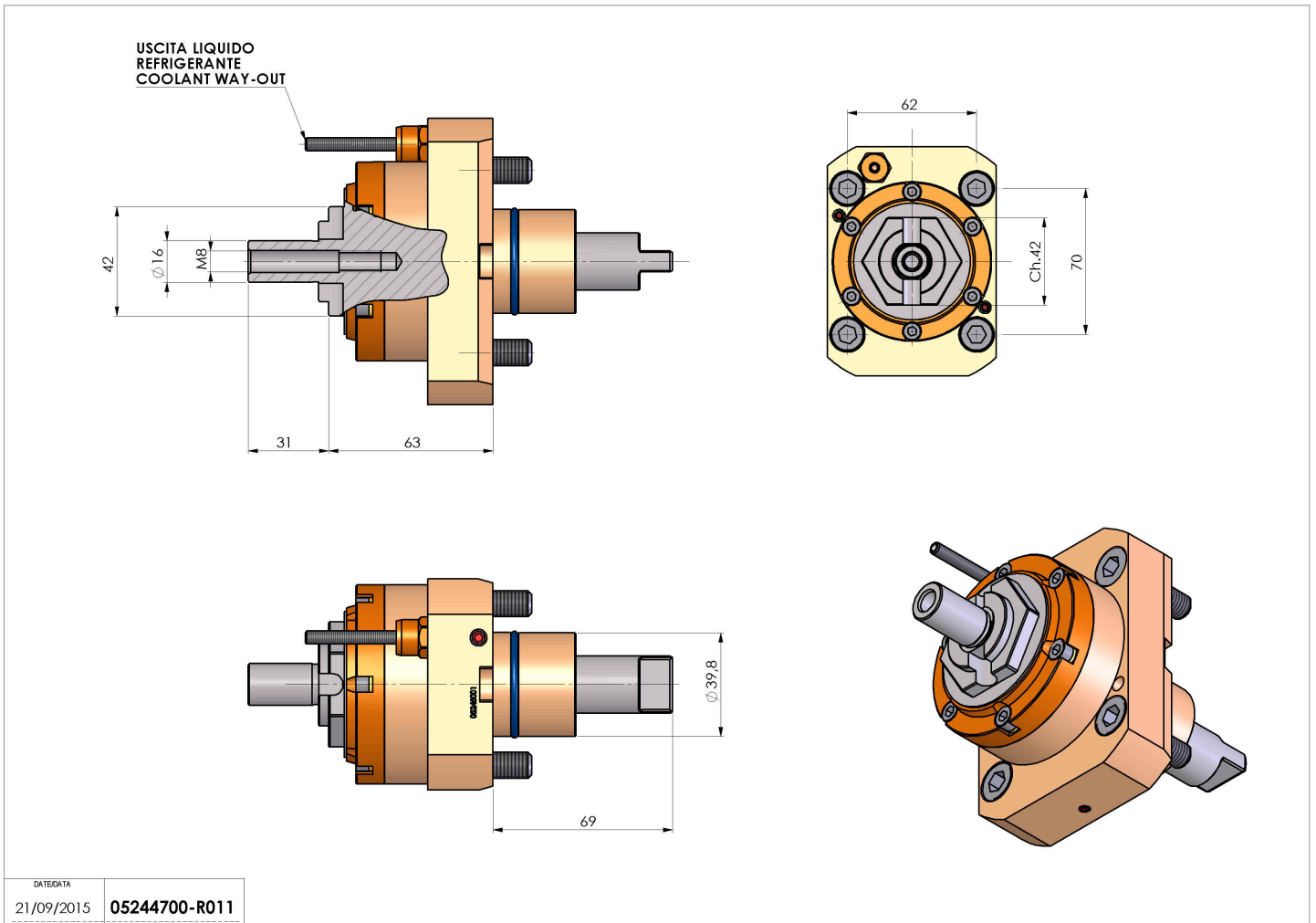

DATE/DATE	
21/09/2015	05244700-R011

Subject to technical changes