



05244400 - LT-S D40 ER25F RF H65

Type	LT-S Tool holder straight
Mounting	CYLINDRICAL SHANK 40
Tool output	Collet nut ER 25 F - internal nut
Coolant	Internal coolant
Direction of rotation	r1  r2 
Max speed [rpm]	6000
Max torque [Nm]	40
Ratio	1:1
H [mm]	65
Accessories	
Notes	N.A.
Mounting tips	Not suitable for every application, please check



Always check live tool dimensions on the turret

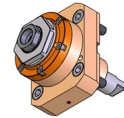
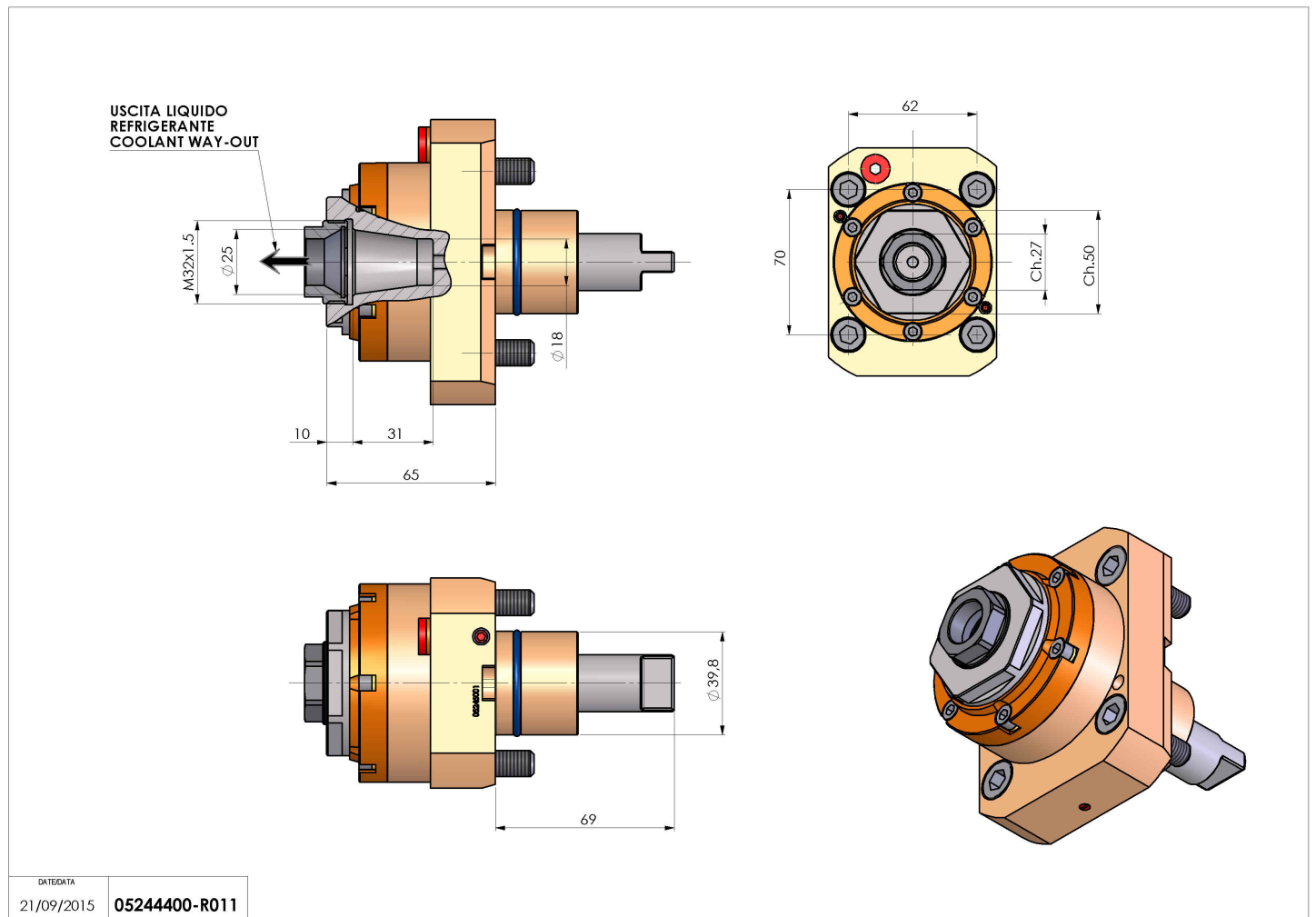

DATE/DATE	05244400-R011
21/09/2015	

Subject to technical changes