



05243100 - LT-S D60 ER40F RF HS H93

Type	LT-S Tool holder straight
Mounting	CYLINDRICAL SHANK 60
Tool output	Collet nut ER 40 F - internal nut
Coolant	Internal coolant
Direction of rotation	r1  r2 
Max speed [rpm]	10000
Max torque [Nm]	63
Ratio	1:1
H [mm]	93
Accessories	N.A.
Notes	N.A.
Mounting tips	Not suitable for every application, please check



Always check live tool dimensions on the turret

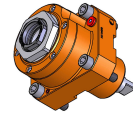
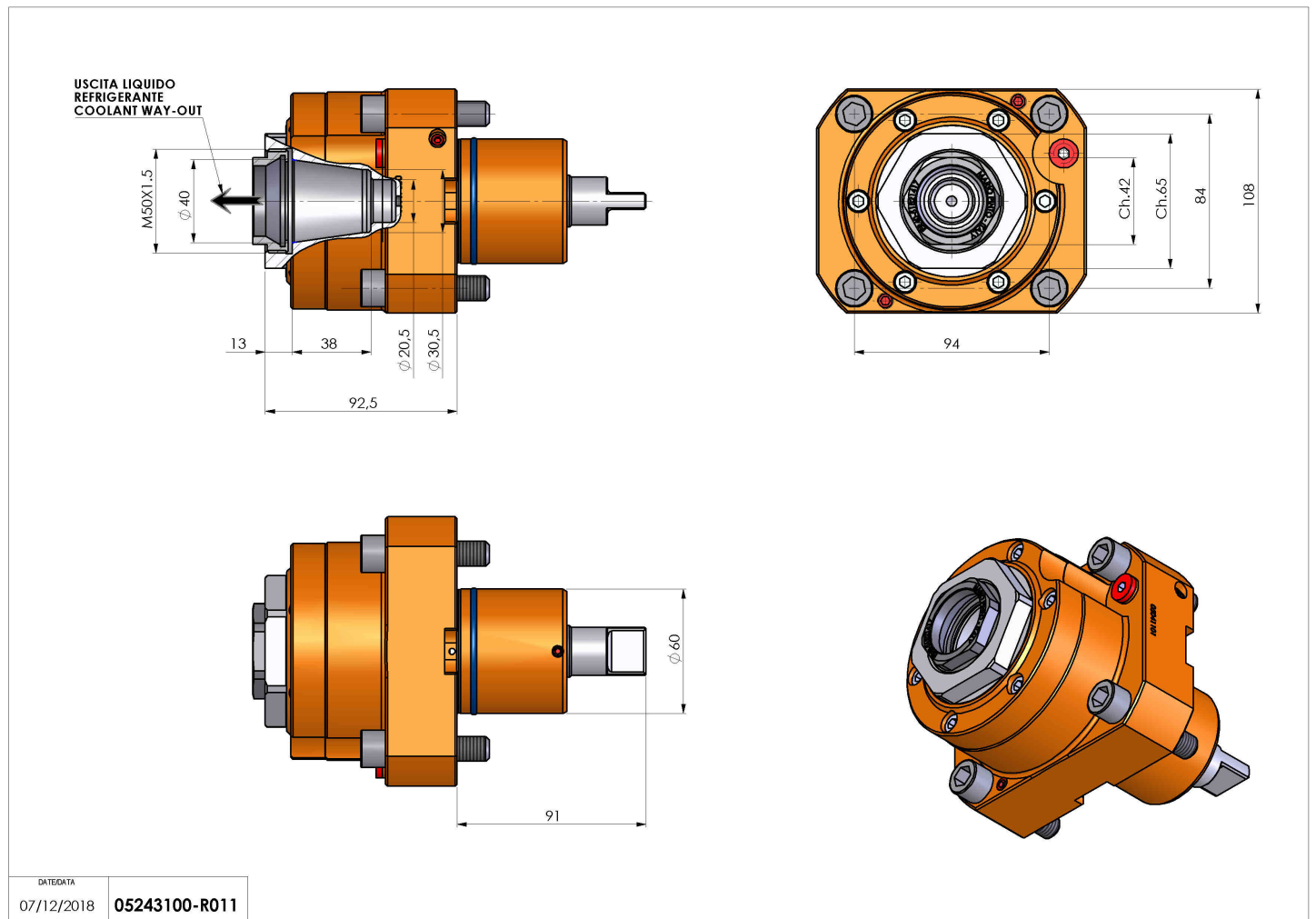

Subject to technical changes