

# 05242700 - LT-S D40 ER32 RF HS H87

<b>Type</b>	LT-S Tool holder straight
<b>Mounting</b>	CYLINDRICAL SHANK 40
<b>Tool output</b>	Collet nut ER 32
<b>Coolant</b>	Internal coolant
<b>Direction of rotation</b>	r1 ↻ r2 ↻
<b>Max speed [rpm]</b>	12000
<b>Max torque [Nm]</b>	40
<b>Ratio</b>	1:1
<b>H [mm]</b>	87
<b>Accessories</b>	N.A.
<b>Notes</b>	N.A.
<b>Mounting tips</b>	Not suitable for every application, please check

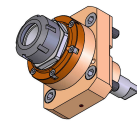

Always check live tool dimensions on the turret

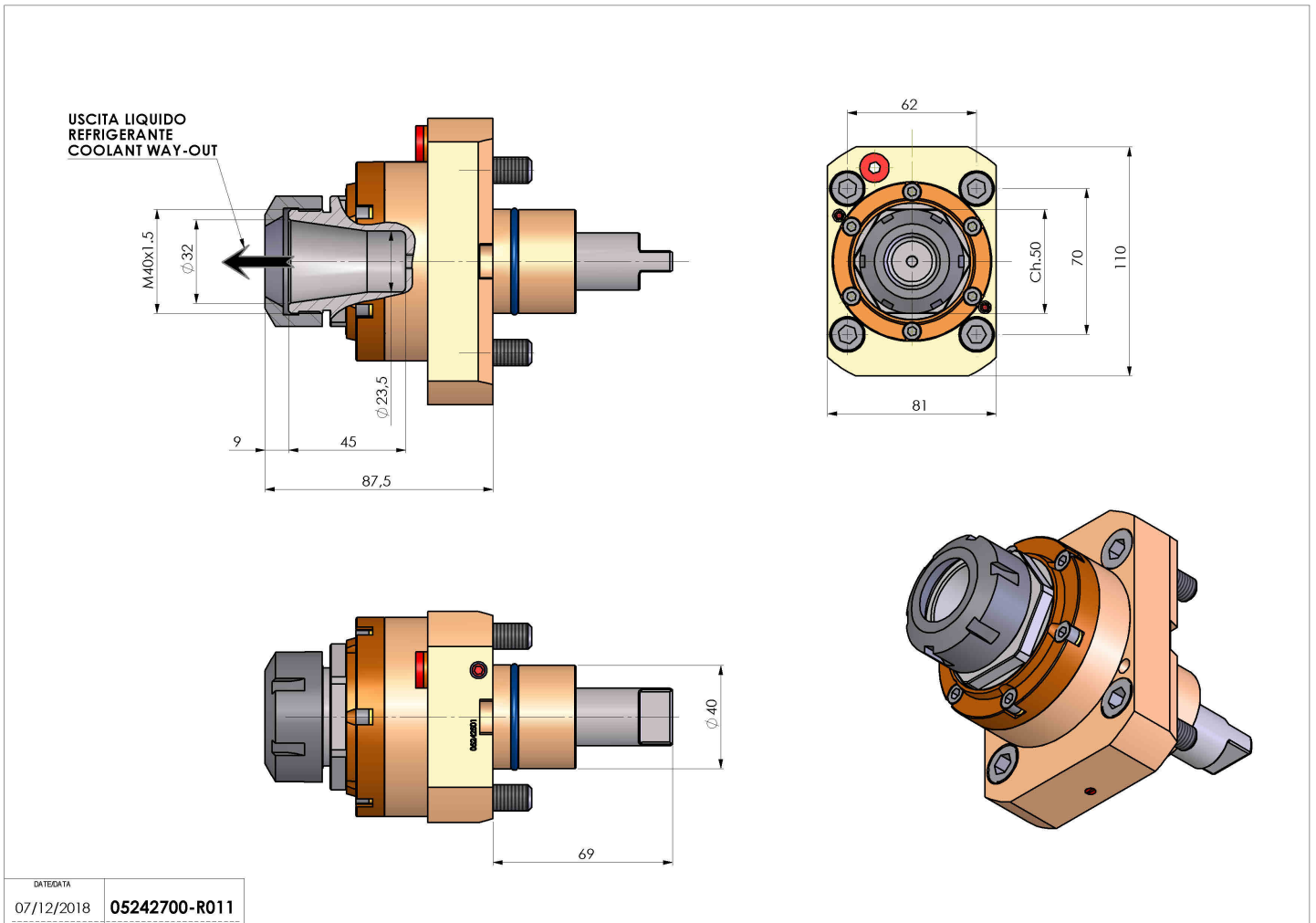

Subject to technical changes