

05222100 - LT-S VDI40 ER32 RF H110 5480SA

Type	LT-S Tool holder straight
Mounting	VDI 40
Tool output	Collet nut ER 32
Coolant	Internal coolant
Direction of rotation	r1 ↻ r2 ↻
Max speed [rpm]	6000
Max torque [Nm]	40
Ratio	1:1
H [mm]	110
Accessories	
Notes	N.A.
Mounting tips	Not suitable for every application, please check

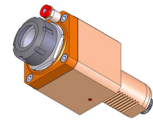

ATTENZIONE: VERIFICARE L'ORIENTAMENTO DELLA DENTATURA VDI

Always check live tool dimensions on the turret

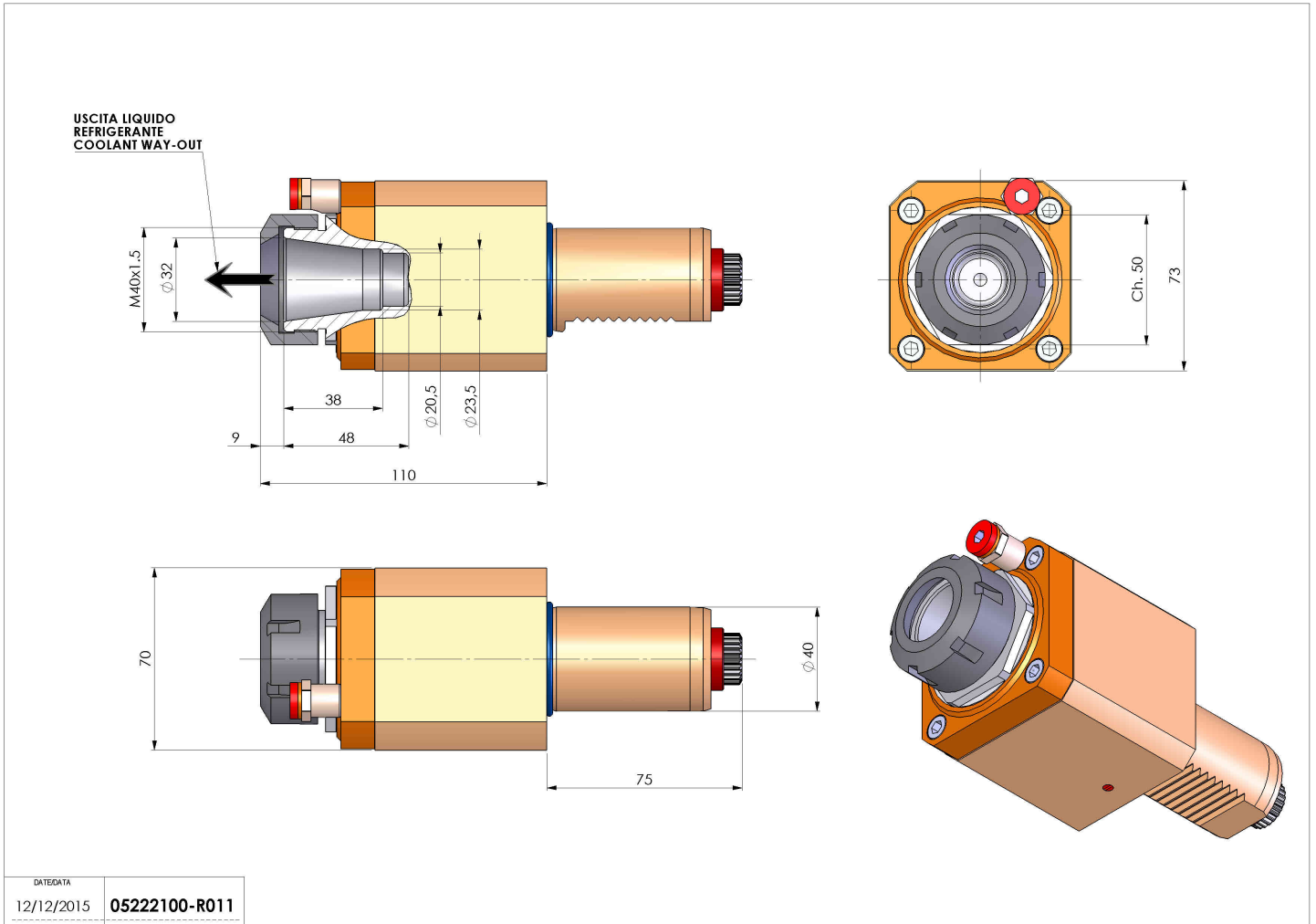

Subject to technical changes